



Fusion Console

Installation & User's Guide Includes StudioEngine and PowerStation



Manual Rev 4 (3.2) - Nov 2017
p/n 1490-00109-005

Notices and Cautions

CAUTION:

The installation and service instructions in this manual are for use by qualified personnel only. To avoid electric shock, do not perform any servicing other than that contained in the operating instructions unless you are qualified to do so. Refer all servicing to qualified personnel.

This instrument has an autoranging line voltage input. Ensure the power voltage is within the specified range of 100-240v. The ~ symbol, if used, indicates an alternating current supply.



This symbol, wherever it appears, alerts you to the presence of uninsulated, dangerous voltage inside the enclosure – voltage which may be sufficient to constitute a risk of shock.



This symbol, wherever it appears, alerts you to important operating and maintenance instructions. Read the manual.

CAUTION: DOUBLE POLE/NEUTRAL FUSING

The instrument power supply incorporates an internal fuse. Hazardous voltages may still be present on some of the primary parts even when the fuse has blown. If fuse replacement is required, replace fuse only with same type and value for continued protection against fire.

WARNING:

The product's power cord is the primary disconnect device. The socket outlet should be located near the device and easily accessible. The unit should not be located such that access to the power cord is impaired. If the unit is incorporated into an equipment rack, an easily accessible safety disconnect device should be included in the rack design.

To reduce the risk of electrical shock, do not expose this product to rain or moisture. This unit is for indoor use only.

This equipment requires the free flow of air for adequate cooling. Do not block the ventilation openings in the top and sides of the unit. Failure to allow proper ventilation could damage the unit or create a fire hazard. Do not place the units on a carpet, bedding, or other materials that could interfere with any panel ventilation openings.

If the equipment is used in a manner not specified by the manufacturer, the protection provided by the equipment may be impaired.

WARNUNG:

Die Installations- und Serviceanleitung in diesem Handbuch ist für die Benutzung durch qualifiziertes Fachpersonal. Um Stromschläge zu vermeiden führen Sie keine andere Wartung durch als in dieser Betriebsanleitung aufgeführt, es sei denn Sie sind dafür qualifiziert. Überlassen Sie alle Reparaturarbeiten qualifiziertem Fachpersonal.

Dieses Gerät hat eine automatische Bereichseinstellung der Netzspannung.
Stellen Sie sicher, dass die verwendete Netzspannung im Bereich von 100-240V liegt.
Das Symbol ~, falls verwendet, bezeichnet eine Wechselstromversorgung.



Dieses Symbol, wo immer es auftaucht, macht Sie auf nicht isolierte, gefährliche elektrische Spannung (ausreichend um einen Stromschlag hervorzurufen) innerhalb des Gehäuses aufmerksam. Spannungen.



Dieses Symbol, wo immer es auftaucht, weist Sie auf wichtige Bedienungs- und Wartungsanleitung hin. Lesen Sie die Bedienungsanleitung.

ACHTUNG: ZWEIPOLIGE ABSICHERUNG / NULLEITER ABSICHERUNG

Das Netzteil des Gerätes hat eine interne Sicherung eingebaut. Auch wenn die Sicherung durchgebrannt ist, können auf einigen primären Bauteilen noch gefährliche Spannungen vorhanden sein. Wenn ein Austausch der Sicherung erforderlich ist, ersetzen Sie die Sicherung nur mit gleicher Art und Wert für den kontinuierlichen Schutz gegen Feuer.

WARNUNG:

Das Gerätenetzkabel ist die Haupttrennvorrichtung. Die Steckdose sollte sich in der Nähe des Gerätes befinden und leicht zugänglich sein. Das Gerät sollte nicht so angeordnet sein, dass der Zugang zum Netzkabel beeinträchtigt ist. Wird das Gerät in ein Rack eingebaut, sollte eine leicht zugängliche Sicherheitstrennvorrichtung in den Rack-Aufbau mit einbezogen werden.

Um die Gefahr von Stromschlägen zu verringern, darf dieses Produkt nicht Regen oder Feuchtigkeit ausgesetzt werden. Dieses Gerät ist nur für die Benutzung im Innenbereich. Dieses Gerät erfordert freie Luftzirkulation für eine ausreichende Kühlung. Blockieren Sie nicht die Lüftungsschlitze auf der Geräteoberseite und den Seiten des Gerätes. Unzureichende Belüftung kann das Gerät beschädigen oder Brandgefahr verursachen. Platzieren Sie das Gerät nicht auf einem Teppich, Poster oder andere Materialien welche die Lüftungsöffnungen beeinträchtigen könnten.

Wird das Gerät anders als in der, vom Hersteller angegebenen Weise verwendet, kann der, durch das Gerät gegebene Schutz beeinträchtigt werden.

USA CLASS A COMPUTING DEVICE INFORMATION TO USER. WARNING:

This equipment generates, uses, and can radiate radio-frequency energy. If it is not installed and used as directed by this manual, it may cause interference to radio communication. This equipment complies with the limits for a class a computing device, as specified by fcc rules, part 15, subpart j, which are designed to provide reasonable protection against such interference when this type of equipment is operated in a commercial environment. Operation of this equipment in a residential area is likely to cause interference. If it does, the user will be required to eliminate the interference at the user's expense. Note: objectionable interference to tv or radio reception can occur if other devices are connected to this device without the use of shielded interconnect cables. Fcc rules require the use of shielded cables.

CANADA WARNING:

“This digital apparatus does not exceed the class a limits for radio noise emissions set out in the radio interference regulations of the Canadian department of communications.”

“Le présent appareil numérique n'émet pas de bruits radioélectriques dépassant les limites applicables aux appareils numériques (de class a) prescrites dans le règlement sur le brouillage radioélectrique édicté par le ministère des communications du Canada.”

CE CONFORMANCE INFORMATION:

This device complies with the requirements of the EEC council directives:

- 93/68/EEC (CE MARKING)
- 73/23/EEC (SAFETY – LOW VOLTAGE DIRECTIVE)
- 89/336/EEC (ELECTROMAGNETIC COMPATIBILITY)

Conformity is declared to those standards: EN50081-1, EN50082-1.

Fusion Manual

© 2014-2017 TLS Corp. Published by Axia Audio/TLS Corp. All rights reserved.

TRADEMARKS

Axia Audio and the Axia and Fusion logos are trademarks of TLS Corp. All other trademarks are the property of their respective holders.

NOTICE

All versions, claims of compatibility, trademarks, etc. of hardware and software products not made by Axia Audio which are mentioned in this manual or accompanying material are informational only. Axia makes no endorsement of any particular product for any purpose, nor claims any responsibility for operation or accuracy. We reserve the right to make improvements or changes in the products described in this manual which may affect the product specifications, or to revise the manual without notice.

WARRANTY

This product is covered by a five year limited warranty, the full text of which is included in this manual.

UPDATES

The operation of Fusion is determined largely by software. We routinely release new versions to add features and fix bugs. Check the Axia Audio web site for the latest. We encourage you to sign-up for the email notification service offered on the site.

FEEDBACK

We welcome feedback on any aspect of Fusion, or this manual. In the past, many good ideas from users have made their way into software revisions or new products. Please contact us with your comments.

SERVICE

You must contact Axia before returning any equipment for factory service. We will need your unit's serial number, located on the back of the unit. Axia will issue a return authorization number, which must be written on the exterior of your shipping container. Please do not include cables or accessories unless specifically requested by the Technical Support Engineer. Be sure to adequately insure your shipment for its replacement value. Packages without proper authorization may be refused. US customers, please contact Axia Technical Support at +1-216-622-0247. All other customers should contact local representative to make arrangements for service.

We Support You...

BY PHONE / FAX:

- You may reach our 24/7 Support team anytime around the clock by calling +1-216-622-0247.
- For billing questions or other non-emergency technical questions, call +1-216-241-7225 between 9:30 am to 6:00 PM, USA Eastern time, Monday through Friday.
- Our Fax number is +1-216-241-4103.

BY E-MAIL:

- Technical support is available at support@telosalliance.com.
- All other questions, please email inquiry@telosalliance.com.

VIA WORLD WIDE WEB:

The Axia Audio web site has a variety of information which may be useful for product selection and support. The url is telosalliance.com.

REGISTER YOUR PRODUCT

Did you know that all Telos Alliance products come with a 5-Year Warranty? Take a moment to activate your coverage online at <http://telosalliance.com/product-registration/>.

THE TELOS ALLIANCE

1241 Superior Avenue E.
Cleveland, OH., 44114 USA

+1-216-241-7225 (phone)
+1-216-241-4103 (fax)
+1-216-622-0247 (24/7 technical support)

support@telosalliance.com
inquiry@telosalliance.com

Table of Contents

Notices and Cautions	ii	Target Loudness, Loudness Tolerance	39
Fusion Manual	v	Relative Loudness	39
We Support You...	vi	Color Indication	40
War of the Waves	ix	Loudness Range	40
Quickstart	#1	Control	40
Fast Setup – with Axia StudioEngine	1	Fader Options:	40
Creating Your First Source	5	Indication Style:	40
Setting Up And Testing Control Room		Sound4 Remote Control:	41
Monitor Channels	7	What’s Next	41
Quickstart	#2	Chapter 3: Operation.	43
Fast Setup – with Axia PowerStation	9	Main Display	44
Creating Your First Source	13	Basic Channel Controls	46
Setting Up And Testing Control Room		Expert Monitor Module Controls	47
Monitor Channels	14	Standard Monitor Module Controls	49
Chapter 1: Fusion Anatomy	17	Call Controller + 2-Fader Phone Module	51
StudioEngine and PowerStation Mixing Engines.	17	IP Intercom Module – 20-Station	52
CAN4ETH	21	IP Intercom Module – 10-Station Filmcap	53
Fusion Power Supply	22	Switch Modules (not shown)	53
Console Modules	22	What’s Next	53
What’s Next	22	Chapter 4: VMix and VMode	55
Chapter 2: Configuration Basics	23	Virtual Mixing with VMix	55
Working With Profiles.	23	What’s it all about?	55
Source Profiles	23	VMix Main Controls	56
Create the Operator’s Mic Source Profile	25	VMix Submixer Controls.	56
Create a Guest Mic Source Profile	27	VMix Submixer Advanced Options	57
Other Helpful Options: Knob Function	28	Some VMix Examples	58
Other Helpful Options: Default Backfeed	28	A Mix of Sources to Monitor.	58
Other Mic Profile Types	28	Virtual VMix Control.	58
Create a CD Player Source (Line Source Type)	29	Combining VMix with Pathfinder Routing Control	58
Create a Telephone Source (Phone Source Type)	31	GPIO control of your VMIX with Pathfinder	59
Advanced Stuff: A Codec Source With		Manipulating Streams With VMode	60
Custom Backfeed.	33	Input:	61
Show Profiles	37	Mode:	61
How to Create A Show Profile	37	Output:	62
Other Configuration Options	38	Some VMode examples	63
User Logo:	38	Create a Mono Stream From One Side of a	
Clock:	38	Stereo Channel	63
GUI Settings:	38	Create a Split Record Feed from Multiple Sources	64
Loudness Meter Options:	38	Create a stereo Livewire stream from a 2-channel	
Enable Loudness Meter.	39	AES67 stream.	65
		What’s Next	65

Chapter 5 Working With Phones	67
Phone Setup Choices	67
Setting Up for EU Phone Operation	68
Setting Up for US Phone Operation.	69
Show Profile Settings For US Phone Operation	69
Source Profile Settings for US Phone Operation – VX & Nx Systems	70
Source Profile Settings for US Phone Operation – Hx6 & iQ6 Systems	72
Operating Options	73
Setting up for GPIO control (“No Phone Control”).	74
Additional Phone Type Source Profile Options	75
Appendix A: Advanced Configuration Reference	77
Part 1 – Magic Key Sequences	77
Part 2 – Show Profiles Options	78
Channel Screen Options	78
General Controls Section	78
Individual Headphones Section	83
Record Mode Section.	83
Auxiliary Send & Return Screen Options	84
Monitor Section Screen Options	85
General Monitor Settings Section	85
Additional Meters Section	87
Sources For External 1 & 2 Section	88
Control Room Monitor Options Section	88
Control Room Headphones Options Section.	89
Studio Monitor Options Section	90
Master Module Control Lock Map Section	91
Record Mode Screen Options	91
Record Mode Configuration Section	91
Flexible Record Mode Options Section	92
Group Start Screen Options	93
Automix Screen Options	93
Phone Screen Options	93
Source Profile.	94
Line and Computer Player	94
Operator and CR Producer Microphone	100
CR Guest, Studio Guest, External microphone	101
Codec.	103
Phone	105
Appendix B: Configuring GPIO.	107
GPIO Port Definitions.	107

GPIO Operator’s Microphone Logic	108
GPIO Control Room Guest Microphone Logic	109
GPIO Producer’s Microphone Logic	110
GPIO Line Input Logic.	111
GPIO Codec Logic	112
GPIO Telephone Hybrid Logic	113
GPIO Control Room Monitor Logic	114
GPIO Computer Playback Device Logic.	115
About GPIO Connections	116

Appendix C: Specifications 119

Microphone Preamplifiers.	119
Analog Line Inputs	119
Analog Line Outputs	119
Digital Audio Inputs and Outputs.	120
Frequency Response	120
Dynamic Range	120
Equivalent Input Noise	121
Total Harmonic Distortion + Noise	121
Crosstalk Isolation, Stereo Separation and CMRR	121
Audio Processing	121
Equalizer	121
Compressor.	121
Expander/Noise Gate	122
De-esser.	122
Power Supply AC Input, StudioEngine	122
Power Supply AC Input, Element Power Supply/GPIO	122
Power Supply AC Input, PowerStation Aux & Main	122
Operating Temperatures.	122

Appendix D: CE Declaration of Conformity 123

Appendix E: Warranty 125

Telos Alliance Limited Warranty	125
Shipping Costs and Warranty Service:	126

Appendix F: New Features. 127

Automix	127
Fader Accessory Panel	129
AES67/SIP-Unicast.	129
Source “unload”	130
AES67 support	130

War of the Waves

Dear Valued Customer,

It's with great pride and a tip of the hat to an incredible team that I congratulate you on your new Telos Alliance product. Everything we do here at the radio division of the Telos Alliance is with one end goal in mind: To help broadcasters declare victory in extremely competitive environments. By purchasing this product from us, in essence, you have declared war on your competition.

After all, the majority of Telos Alliance employees were broadcasters themselves once, and the products we've developed over the years have been designed as solutions to specific issues faced on the front lines of our industry. We're right there in the trenches with you and have the weapons you need in your arsenal.

Telos Systems is a catalyst to out-of-this-world sound, with the most powerful and popular broadcast telephone systems in the industry; IP/ISDN codecs and transceivers; plus processing/encoding for streaming audio. We built an industry on the back of these amazing telephony systems, and they are still going strong.

While we at the Telos Alliance never forget our roots, we are also blazing trails in terms of new technologies like stream-encoding and AoIP, so that all types of broadcasters can excel in this ever-evolving digital world. Omnia Audio not only lets you stand out on the dial with your unique signature sound via legendary audio processors, audio codecs, and microphone processing, it lets you give your listeners a better streaming experience across devices with innovative stream encoding/processing software and hardware.

Axia Audio is a driving force behind the AES67 AoIP standard, and its networked AoIP radio consoles, audio interfaces, networked intercom, and software products continue to move AoIP adoption forward and help broadcasters streamline operations with cohesive, smart, and feature-rich AoIP ecosystems.

Last, but certainly not least, 25-Seven has traditionally been known for its audio delays, but its Voltair watermark monitor/processor has made a name for itself more recently as the disruptive product that helped broadcasters take back their ratings and harness the true power of their listening audiences.

You work so hard on your programming day-in and day-out, it deserves technology that will optimize sound and performance at every point in the airchain and online. Armed with Telos products, you have what you need to set your competition squarely in your crosshairs.

With that, I'll leave you to prep your armaments. I hope that you will enjoy your Telos Alliance products for many years to come!

Sincerely,
Frank Foti
CEO, The Telos Alliance



Intentionally Left Blank

Quickstart #1

Fast Setup – with Axia StudioEngine

Setup of a networked audio mixing console, though we have made it as easy as possible, is challenging to condense into a few pages. The following material is intended to help the busy engineer get up and running in a few minutes.

This Quickstart section setup assumes a few things:

- That the reader has some knowledge of network basics and network terminology,
- That the reader is familiar with other Axia Livewire products,
- That the reader is familiar with the anatomy of the Fusion system,
- And that the reader has a correctly configured network switch

Once you're up and running, please peruse the remainder of this manual to gain in-depth knowledge of more advanced options.

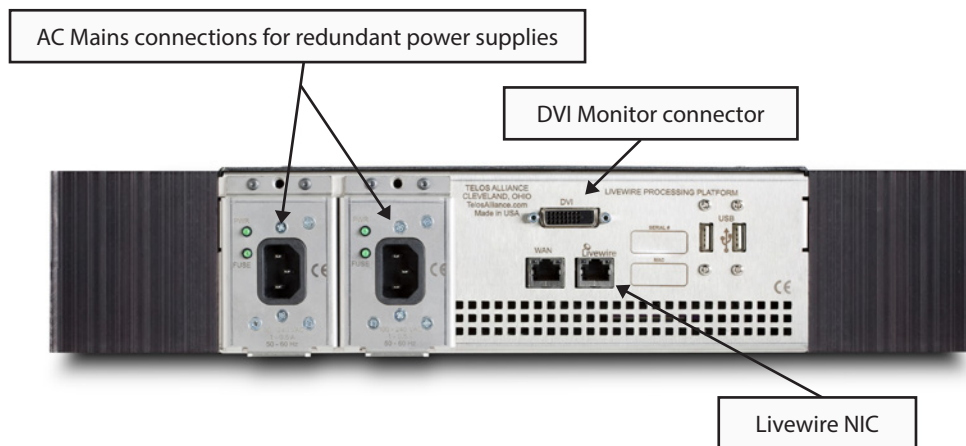

To begin, connect a 1080p widescreen computer monitor to the DVI port on the Axia StudioEngine's rear panel. Also connect the RJ-45 port marked with the Livewire logo to a port on your AoIP network's local switch using a CAT-6 Ethernet cable.

Using the IEC cables supplied, connect the StudioEngine's power supply input to AC mains.

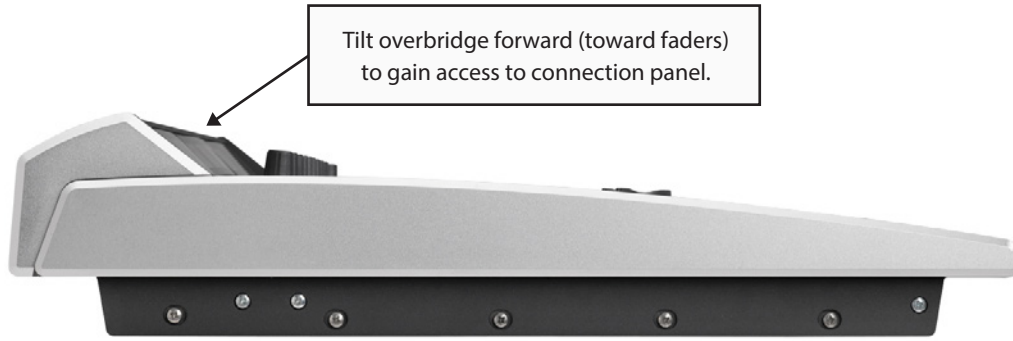

Next, connect the Power cable supplied with your Fusion Power Supply to the Power connection on the board located beneath the overbridge of the Fusion surface.

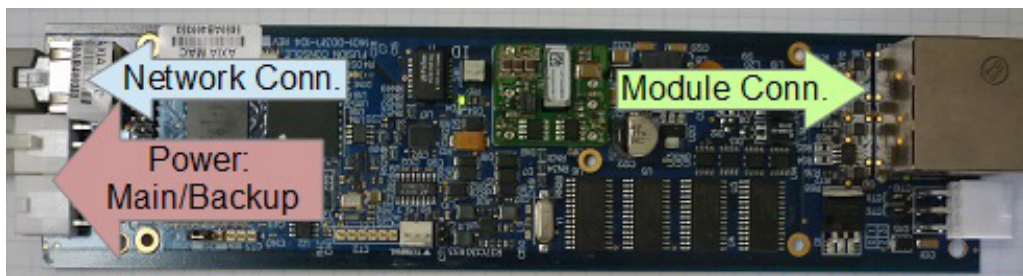

Also connect your Fusion to your AoIP network's local switch, using a CAT-5e Ethernet cable.

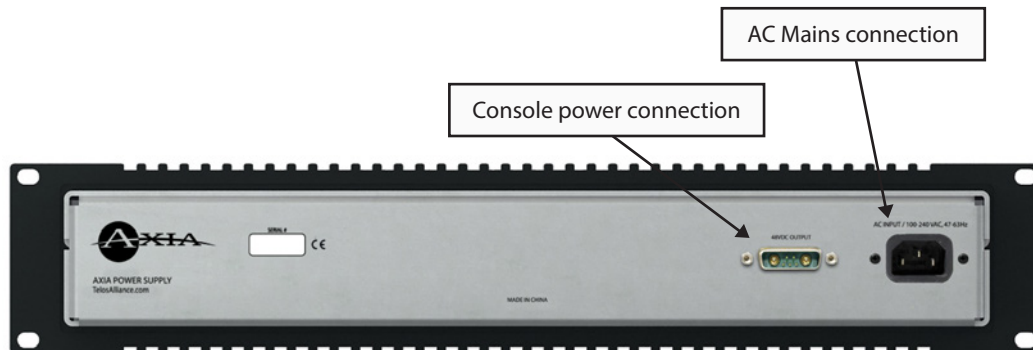

Connect the Power cable from your Fusion console to the marked power supply port on the rear of your Fusion Power Supply, and then connect the Fusion Power Supply to AC mains using the IEC cable supplied.

When the StudioEngine has booted, its display will indicate an error state. Don't panic! An IP address needs to be entered. To do this:

1. Tap the rotary encoder on the front panel, once. A menu view will appear.

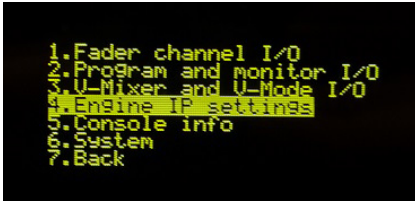

2. Rotate the encoder to highlight “Engine IP settings”, and tap the encoder again to select it. A new menu will appear.
3. Rotate the encoder to select “Net Address” and tap to select.
4. Rotate the encoder to move the onscreen cursor. A tap on any of the cursor position allows you to edit its numeric value; rotate the encoder to increment or decrement the value and tap to accept the change. Repeat this until the IP address you desire is entered.
5. Select the check mark to the right of the IP address to accept.
6. Repeat this process for the Netmask and Gateway fields, as needed.
7. Select “Console” and change the option to “Fusion”.
8. Select “OK.” After selecting OK, respond affirmative to the following notice to reboot the engine with its new settings.

The next step requires a Web browser on a PC connected to your AoIP network. Open your browser and enter the IP you assigned to your StudioEngine in the URL bar; an authentication window will appear. Enter the following values:

- Username = *user*
- Password = <leave blank>

Select “OK” and your Fusion console’s control center will be loaded.

Filesystem	Size	Used	Available	Use%
Memory	1.97 GB	215.69 MB	1.76 GB	10.7%
/	438.48 MB	118.45 MB	320.03 MB	27.0%
/var/log	100.00 MB	48.00 KB	99.95 MB	0.0%
/boot/grub	2.41 MB	1.36 MB	1.05 MB	56.5%
/mnt/persistent_rw_fs	19.53 MB	6.09 MB	13.44 MB	31.2%

1. From the links under the **Mix Engine** heading, select Network.
2. Click the **Install** button displayed at the bottom of the Network page. A new page will load.

MAC	current IP	hostname
58:50:AB:40:03:53	192.168.2.27	ETH4CAN
(none)		
58:50:AB:40:03:53	192.168.2.27	ETH4CAN

3. Enter the value **1** into the **Console count** field and click the **Apply Console Count** button.
4. The software will display a list of the consoles found on your network. Select your Fusion from the drop-down list.
5. Click the **Apply IP** button to set the IP address of your Fusion, and to link it with the StudioEngine.

Your Fusion console is now connected! Notice that the displays above each fader strip read INACTIVE. One more fast step will complete the setup process.

Press the * (star) and 2 keys on the numeric keypad of your console's Monitor module. Hold them until the displays change to read CAPTURE.

Release the * and 2 keys, then press the **Enter** key (Expert monitor module) or # key (Standard monitor module).

Congratulations! Your Fusion console is now configured and ready to load sources. The displays above each fader strip will now contain a number indicating the fader position.

Creating Your First Source And Assigning It To A Fader

You'll use your Web browser and the Fusion interface to create your first audio source in just a few fast steps.

1. In the side menu under the **Console** heading, select **Sources**, then click the **Create new source profile** button.

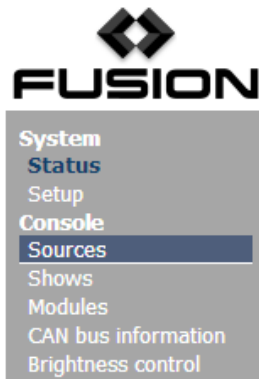

2. Enter a name for your new audio source in the **Source name** field.

- Press the browse button to the right of the Primary source field; a pop-up window will appear with a list of sources available on your Axia network. Select the desired source from the list, and click the OK button.

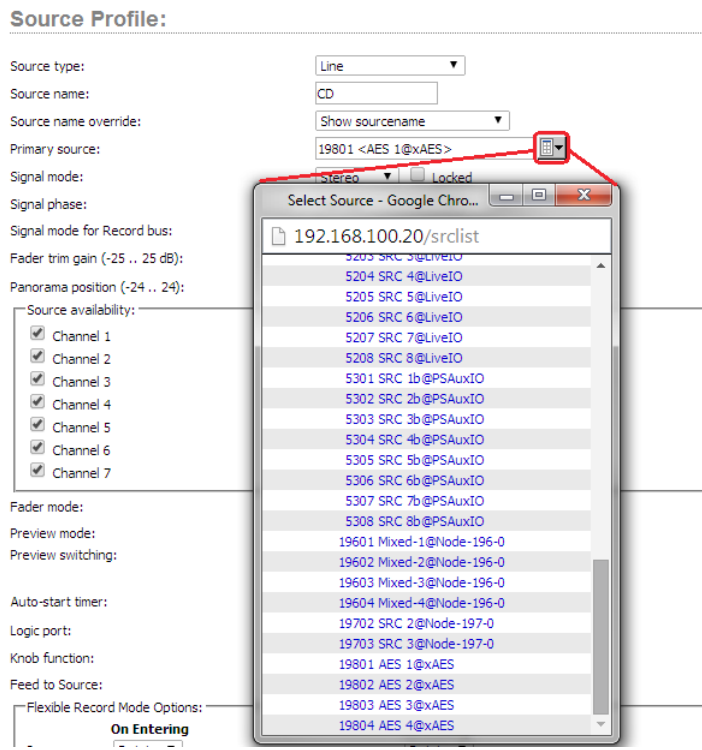

- Your Source Profile has been created! Your screen should show an entry similar to that shown below.

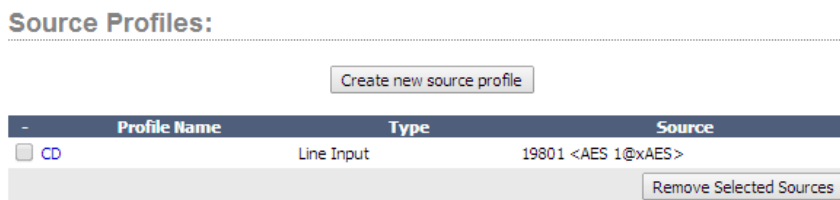

Setting Up And Testing Control Room Monitor Channels

1. In the side menu, under the **Mix Engine** heading, select the **Prog and mon out** option.

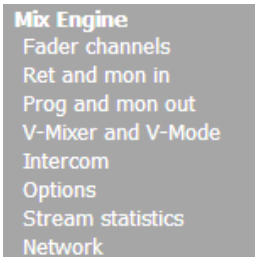

2. Enter the planned Channel Numbers for the StudioEngine outputs (Livewire Sources). Click the **Apply** button.
3. On your Fusion console, press the Options knob found at the top of any fader strip. Your video monitor's center section will change, showing the Channel Options display.



4. Rotate the Options encoder to highlight the Current Source window. (Highlighted options are bordered in yellow), and then press the Encoder.

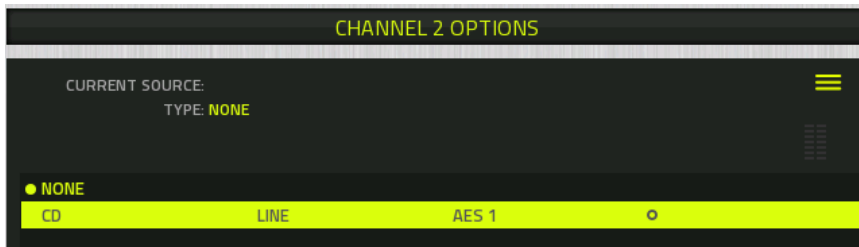

5. You'll now see a list of your available Sources (in this case, just one: the one we just configured.)
6. Rotate the Options encoder to highlight the source you just created. Press the encoder to select the highlighted source.
7. Press the Program 1 key on the fader strip; it will illuminate to show you've assigned that fader to PGM-1. Press the ON key at the bottom of the fader strip and move the fader up. Congratulations: you've got audio! The meters on your display should be active, as shown below.

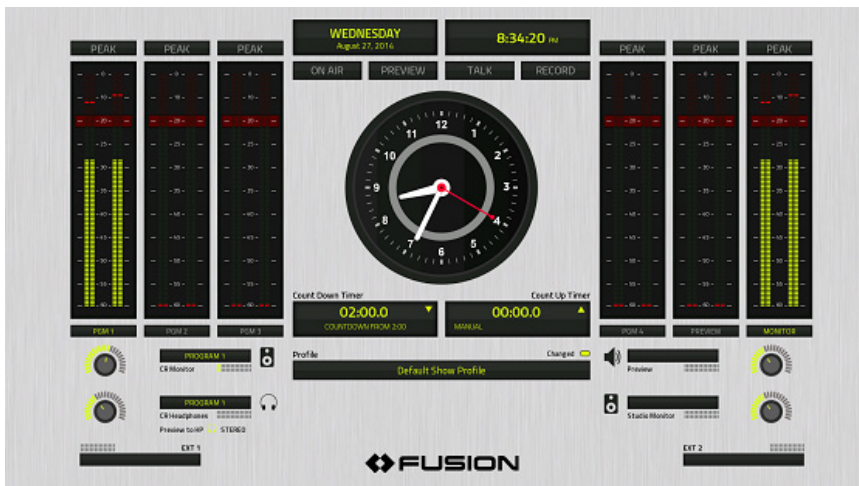

To hear the audio, make sure you have selected Program 1 as your CR Monitor source, using the controls on your Monitor module, and that the volume is at an appropriate level (the level meters onscreen will show the relative volume you've set). Also, make sure the xNode feeding your speaker has been configured to the CR Monitor source you assigned a channel number to.

Now, sit back and enjoy some music as you read the remainder of this manual, or continue to explore the Configuration pages of your StudioEngine; the details of these options can be found in the Configuration section of this manual.

Quickstart #2

Fast Setup – with Axia PowerStation

Setup of a networked audio mixing console, though we have made it as easy as possible, is challenging to condense into a few pages. The following material is intended to help the busy engineer get up and running in a few minutes.

This Quickstart section setup assumes a few things:

- That the reader has some knowledge of network basics and network terminology,
- That the reader is familiar with other Axia Livewire products,
- That the reader is familiar with the anatomy of the Fusion system,
- And that the reader has a correctly configured network switch

Once you're up and running, please peruse the remainder of this manual to gain in-depth knowledge of more advanced options.

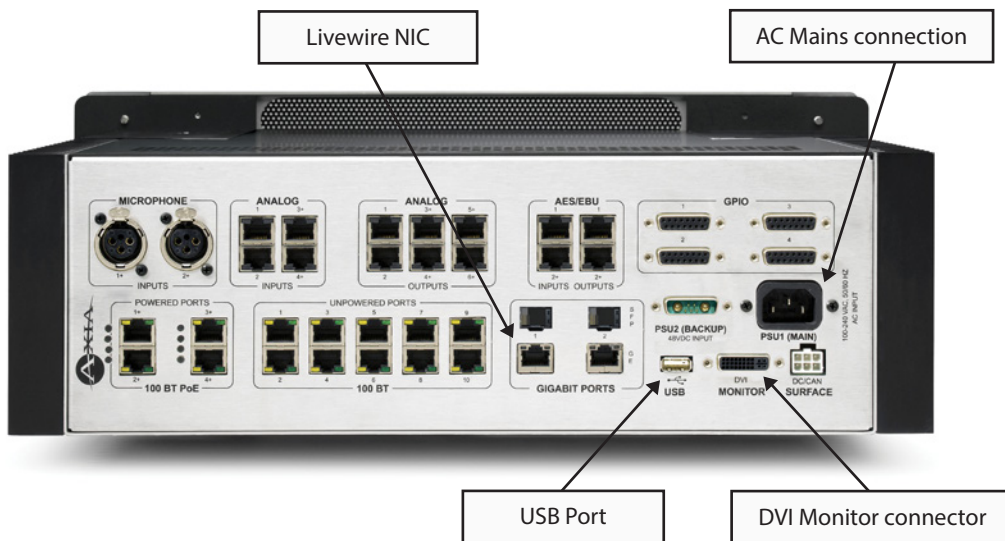

To begin, connect a 1080p widescreen computer monitor to the DVI port on the Axia PowerStation Main rear panel.

Connect a USB keyboard to the USB port on the rear of your PowerStation Main.

Using the IEC cable supplied, connect the PowerStation's power supply input to AC mains. Allow PowerStation to boot; a Setup screen will appear on your monitor.

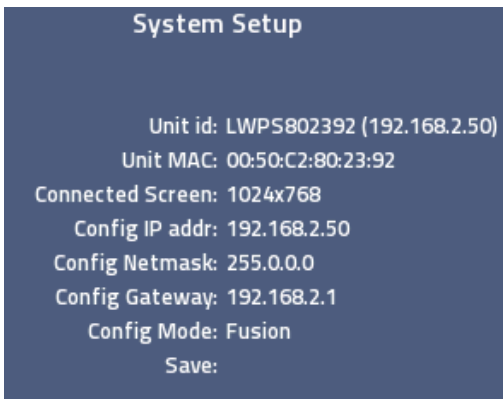

To set up your PowerStation:

1. Press your keyboard's up-arrow key until the **Config IP addr** line is highlighted in yellow text.
2. Press the Backspace key to clear values, and use the number keys to enter new values and assign an IP address to the PowerStation.
3. Use the arrow keys to move to the **Config NetMask** and **Config Gateway** fields, repeat the process to set the needed values.
4. Use the down-arrow key to move to the **Save & Reboot** selection. Press the Enter key and the system will reboot, with the IP address you've entered.
5. Remove the USB keyboard.

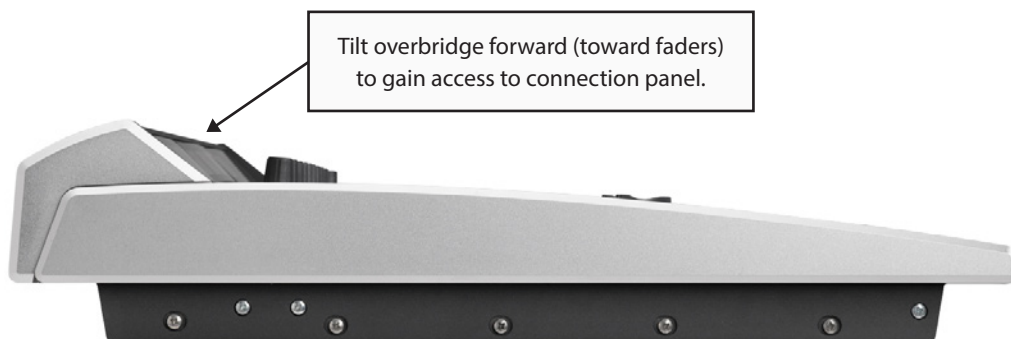

Next, connect one end of the 6-pin Molex power cable supplied with your PowerStation to the Power connection on the board located beneath the overbridge of the Fusion surface.

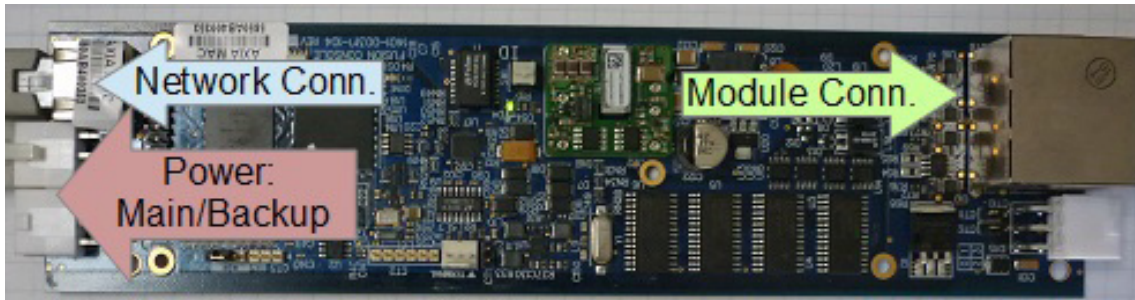

Connect the other end to the Molex connector marked SURFACE on the rear of your PowerStation.

Now, Connect a network patch cable from the board under the Fusion’s overbridge to any available port on the PowerStation’s switch.

The next step requires a Web browser on a PC connected to any Ethernet port on your PowerStation’s switch section. Open your browser and enter the IP you assigned to your PowerStation in the URL bar; an authentication window will appear. Enter the following values:

- Username = *user*
- Password = <leave blank>

Select “OK” and your Fusion console’s control center will be loaded.

PowerStation (PS-Fusion) Control Center

Welcome!

Version information:

Version: 1.0.5.34 (27 Aug 2014)
 Base: PSF-1.3.0w (18-Aug-2014)

System:

Kernel: Linux 2.6.38.8-rtai-aewd+i686
 Uptime: 0 days 00:12
 CPU usage: 0.79%
 Network: 1000Mb/s, full duplex
 Net usage: Rx: 5.206 Mbps, Tx: 38.221 Mbps

File System Information:

Filesystem	Size	Used	Available	Use%
Memory	1001.14 MB	211.87 MB	789.27 MB	21.2%
/	438.48 MB	97.15 MB	341.33 MB	22.2%
/var/log	100.00 MB	52.00 KB	99.95 MB	0.1%
/boot/grub	2.41 MB	1.36 MB	1.05 MB	56.5%
/mnt/persistent_rw_fs	19.53 MB	6.36 MB	13.18 MB	32.5%

1. From the links under the **Mix Engine** heading, select Network.
2. Click the **Install** button displayed at the bottom of the Network page. A new page will load.

3. Enter the value **1** into the **Console count** field and click the **Apply Console Count** button.

Attached Consoles

Console count:

PS CONSOLE: 1

Current MAC:

Console boards found: 1

MAC	current IP	hostname
58:50:AB:40:03:53	192.168.2.27	ETH4CAN

Select:

4. The software will display a list of the consoles found on your network. Select your Fusion from the drop-down list.
5. Click the **Apply IP** button to set the IP address of your Fusion, and to link it with the PowerStation.

Your Fusion console is now connected! Notice that the displays above each fader strip read INACTIVE. One more fast step will complete the setup process.

Press the * (star) and **2** keys on the numeric keypad of your console's Monitor module. Hold them until the displays change to read CAPTURE.

Release the * and **2** keys, then press the **Enter** key (Expert monitor module) or # key (Standard monitor module).

Congratulations! Your Fusion console is now configured and ready to load sources.

Creating Your First Source And Assigning It To A Fader

You'll use your Web browser and the Fusion interface to create your first audio source in just a few fast steps.

1. In the side menu under the **Console** heading, select **Sources**, then click the **Create new source profile** button.

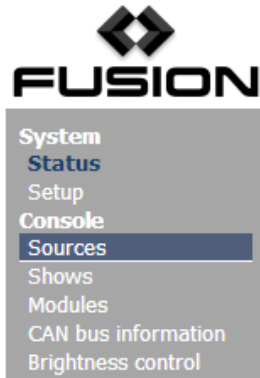

2. Enter a name for your new audio source in the **Source name** field.
3. Press the browse button to the right of the Primary source field; a pop-up window will appear with a list of sources available on your Axia network. Select the desired source from the list, and click the OK button.

Source Profile:

Source type: Line

Source name: CD

Source name override: Show sourcename

Primary source: 19801 <AES 1@xAES>

Signal mode: Stereo

Signal phase: Locked

Signal mode for Record bus:

Fader trim gain (-25 .. 25 dB):

Panorama position (-24 .. 24):

Source availability:

- Channel 1
- Channel 2
- Channel 3
- Channel 4
- Channel 5
- Channel 6
- Channel 7

Fader mode:

Preview mode:

Preview switching:

Auto-start timer:

Logic port:

Knob function:

Feed to Source:

Flexible Record Mode Options: On Entering

Select Source - Google Chro...

192.168.100.20/src/

- 5203 SRC 3@LiveIO
- 5204 SRC 4@LiveIO
- 5205 SRC 5@LiveIO
- 5206 SRC 6@LiveIO
- 5207 SRC 7@LiveIO
- 5208 SRC 8@LiveIO
- 5301 SRC 1b@PSAuxIO
- 5302 SRC 2b@PSAuxIO
- 5303 SRC 3b@PSAuxIO
- 5304 SRC 4b@PSAuxIO
- 5305 SRC 5b@PSAuxIO
- 5306 SRC 6b@PSAuxIO
- 5307 SRC 7b@PSAuxIO
- 5308 SRC 8b@PSAuxIO
- 19601 Mixed-1@Node-196-0
- 19602 Mixed-2@Node-196-0
- 19603 Mixed-3@Node-196-0
- 19604 Mixed-4@Node-196-0
- 19702 SRC 2@Node-197-0
- 19703 SRC 3@Node-197-0
- 19801 AES 1@xAES
- 19802 AES 2@xAES
- 19803 AES 3@xAES
- 19804 AES 4@xAES

4. Your Source Profile has been created! Your screen should show an entry similar to that shown below.

Source Profiles:

-	Profile Name	Type	Source
<input type="checkbox"/>	CD	Line Input	19801 <AES 1@xAES>

Setting Up And Testing Control Room Monitor Channels

1. In the side menu, under the **Mix Engine** heading, select the **Prog and mon out** option.

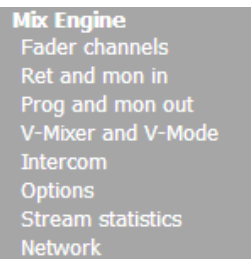

2. Enter the planned Channel Numbers for the PowerStation outputs (Livewire Sources from DSP). Click the **Apply** button.
3. In the side menu, select the **Destinations** link under the **I/O subsystem main** heading.

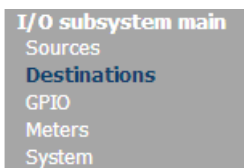

You'll be prompted for a Username and Password. Enter the following values:

- Username = *user*
- Password = <leave blank>

- The designated output on the back of the PowerStation which provides audio to the monitor speaker amplifier needs to be configured for the CR Monitor DSP source. Type a descriptive name in the “Name” field and select the Browse button next to the “Channel” field. From the popup, select the CR Monitor source from the PowerStation.

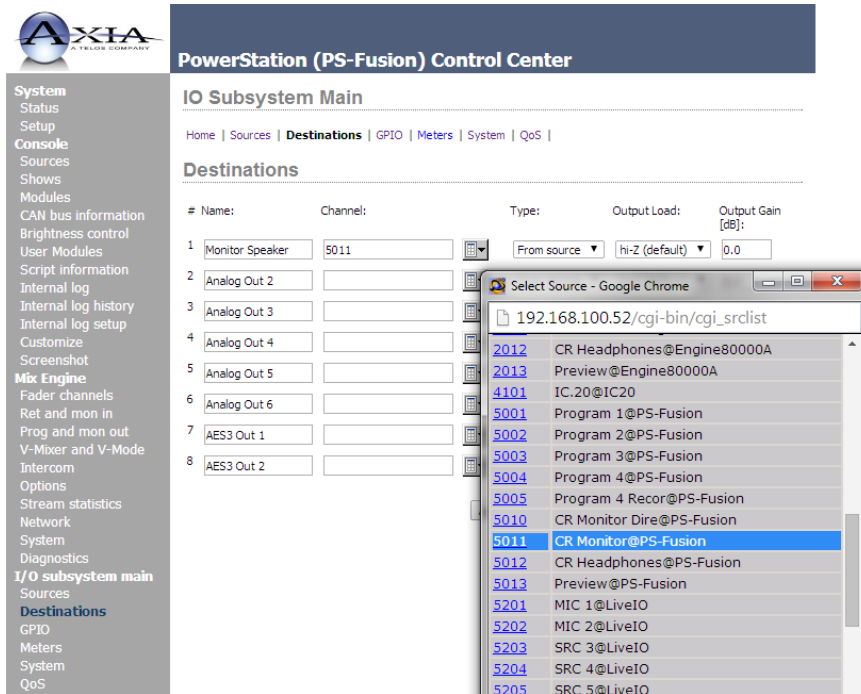

- On your Fusion console, press the Options knob found at the top of any fader strip. Your video monitor’s center section will change, showing the Channel Options display.

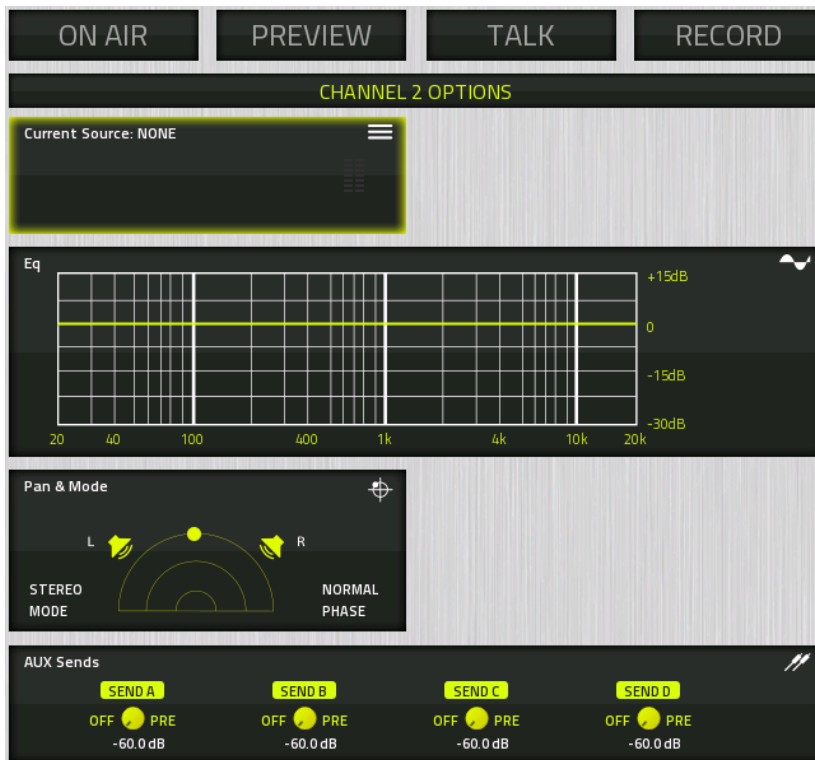

- Rotate the Options encoder to highlight the Current Source window. (Highlighted options are bordered in yellow), and then press the Encoder.

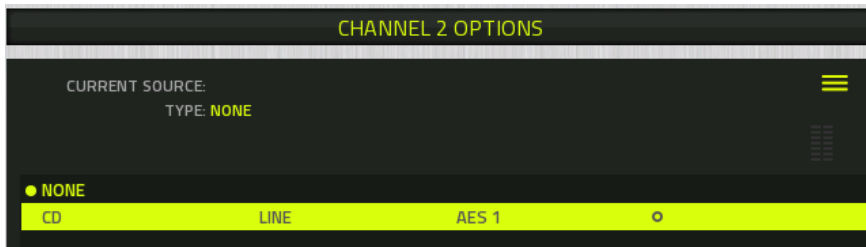

- You'll now see a list of your available Sources (in this case, just one: the one we just configured. If you already have an Axia network deployed, you may see a larger list.)
- Rotate the Options encoder to highlight the source you just created. Press the encoder to select the highlighted source.
- Press the Program 1 key on the fader strip; it will illuminate to show you've assigned that fader to PGM-1. Press the ON key at the bottom of the fader strip and move the fader up. Congratulations: you've got audio! The meters on your display should be active, as shown below.

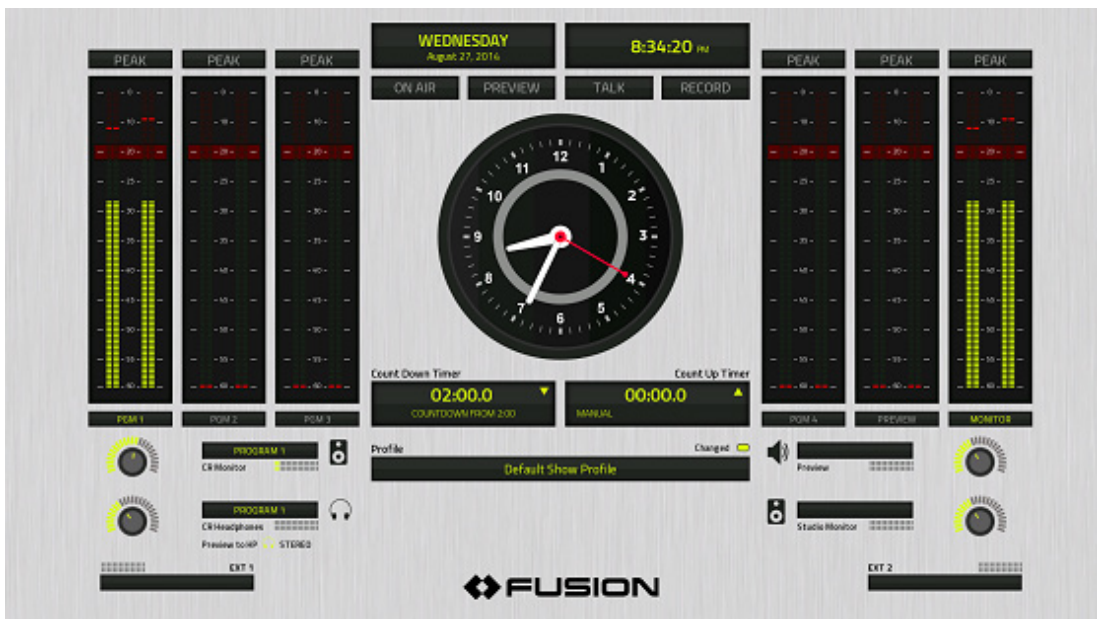

To hear the audio, make sure you have selected Program 1 as your CR Monitor source, using the controls on your Monitor module, and that the volume is at an appropriate level (the level meters onscreen will show the relative volume you've set).

Now, sit back and enjoy some music as you read the remainder of this manual, or continue to explore the Configuration pages of your PowerStation; the details of these options can be found in the Configuration section of this manual.

Chapter 1:

Fusion Anatomy

The Fusion modular control surface is more than a just console — it is a complete studio system, with various components that serve different functions.

This chapter gives an overview of the different components to help familiarize you;. The following chapters will build on this familiarity as we dive deeper into Fusion’s features and capabilities.

StudioEngine and PowerStation Mixing Engines

The StudioEngine and PowerStation mixing engines serve as the “brains” of the studio. Each contains a CPU that powers console operations, as well as the DSP mixing functionality.

Audio from the Axia network enters the mixing engine and is manipulated per the user’s actions on the Fusion surface. The engine’s Console function communicates with the surface and maintains the logical states that are required in a studio environment in addition to controlling the Mix Engine. Those logical states include:

- Muting
- ON/OFF commands
- GPIO control
- Mix conditions
- Source ownership (which mixing surface has control of an active source)
- Phone control

...and many others. The PowerStation mixing engine has additional functionality, which includes networked I/O and an integrated AoIP-tailored network switch.



The front-panel of the StudioEngine has a display and a dual-function rotary encoder. The display normally provides basic system information, along with an “OK” status indicator. If the “OK” indicator is missing from the screen, it’s because something needs attention — in its place will be an error message describing any items the unit’s self-diagnostics consider out-of-the-ordinary.

The display also provides access to the StudioEngine’s menu options. From the OK status view, tapping the encoder activates the menu system, which can be navigated with rotations of the knob, and selections made by taps (pressing the knob in).

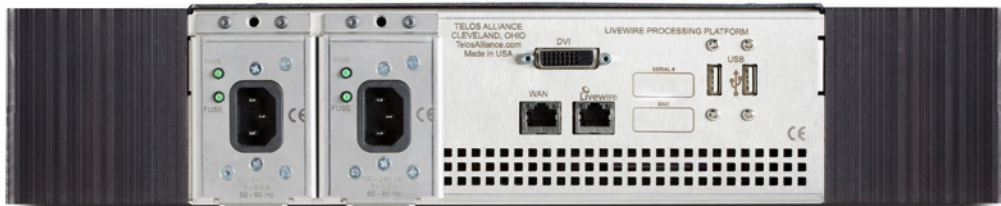

The rear of the Studio Engine has two power supplies, each with standard EAC connectors. The DVI-D video connector is a digital video output intended to be connected to a monitor that supports 1080p resolution.

Below the video connector are two RJ45 ports. The **Livewire** port is used for connection to the Axia network (the second port is reserved for future use). The two USB ports are also for future use, or possible service functionality.



The PowerStation MAIN front panel has no user interface, but does have a number of useful status indicators:

- The **Axia logo**, glowing blue, indicates that power is present in the internal power supply (after redundant-power-supply isolation, if a PowerStation AUX with redundant power is connected)
- The **PSU** indicator shows the status of the power supply:
 - » A **green** indication means all is well.
 - » An **orange** indication notes that the secondary (backup) power supply is not functioning. *(If a PowerStation AUX unit is not installed, software detects this at setup; the orange indication will not be produced in this case.)*
 - » A **red** indication shows that the PowerStation Main's internal power supply has failed, and that power is now being provided by the backup supply in the PowerStation AUX (if installed).
- The **LIVEWIRE** indication represents correct network performance. This should always be illuminated when your PowerStation is connected to a Livewire network; if not, there may be a failure of the internal switch or internal cable.
- The **MASTER** indication shows that this PowerStation is source of network clock sync. If sync is provided by an external master clock or another Livewire device, this will not be illuminated. Only one device can be a source of clock sync (the Clock Master) within a network. If multiple Masters are illuminated in a facility, this suggests a network configuration error or loss of network connectivity to a facilities core switch.
- The **SYNC** indication is typically illuminated, showing that the PowerStation I/O board is receiving network clock:
 - » A **solid green** indication is normal behavior.
 - » A **blinking green** indication tells you that PowerStation's I/O is not synchronized with the network. This can happen momentarily, at boot, as the device syncs with received network packets, or if there is a change in source of clock from one Master to another.
 - » A **red** indication suggests either that no network sync is present, or a possible failure of the I/O board.
- The **OK** indicator lights to show that the DSP engine is functioning and is receiving clock from the network. If it is not lit, either there is no network sync available to the DSP engine, or the main CPU has failed.

The PowerStation AUX has the same front panel as the PowerStation MAIN, and front-panel indicators are similar.

- PowerStation AUX has no **OK** indicator, since there is no main CPU in the AUX.
- The **LINK** indicator lights to show that the I/O board has an active network link.

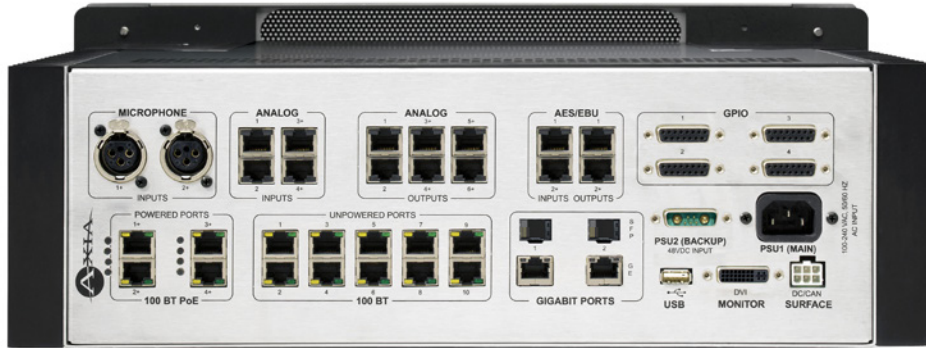

PowerStation MAIN connection panel

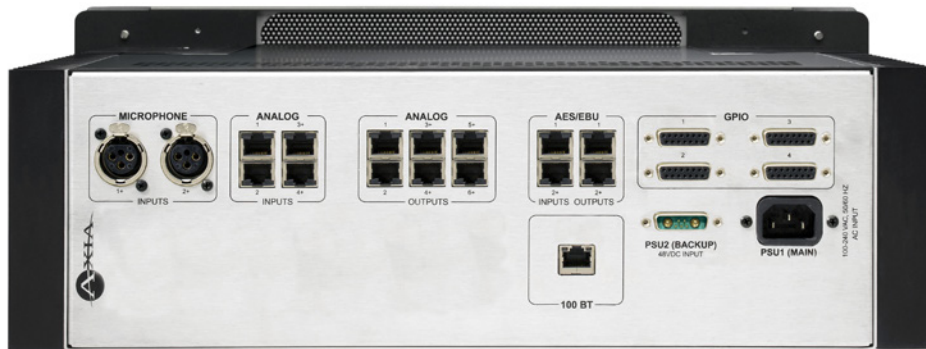

PowerStation AUX connection panel

The rear of the PowerStation is divided into three categories: Input/Output, Network switch, and System ports. The audio inputs on each PowerStation consist of:

- Two (2) XLR microphone inputs
- Four (4) RJ45 stereo analog inputs
- Two (2) RJ45 AES digital audios inputs
- Six (6) RJ45 stereo analog outputs
- Two (2) RJ45 AES digital audio outputs

General Purpose Input Output (GPIO) ports are four (4) DA-15 male connectors. Each DA-15 has 5 solid state relay output pins and 5 opto-isolated input pins

The integrated zero-configuration network switch has four (4) 100MB ports with PoE (Power over Ethernet), ten (10) unpowered 100MB ports, and two (2) 1GB ports with parallel SFP ports. The system ports are a D-subminiature (DA) backup power port, EAC AC power port, USB, DVI-D port for monitor connection, and a 6-pin Molex connector to supply the console with 48v power.

CAN4ETH

Underneath the overbridge of the Fusion surface is the board that links the console modules to the main CPU of either your StudioEngine or PowerStation. The surface uses CANBus (Control Area Network) as a common interface for modules, then links the surface's mixing modules to its associated CPU via an Ethernet link.

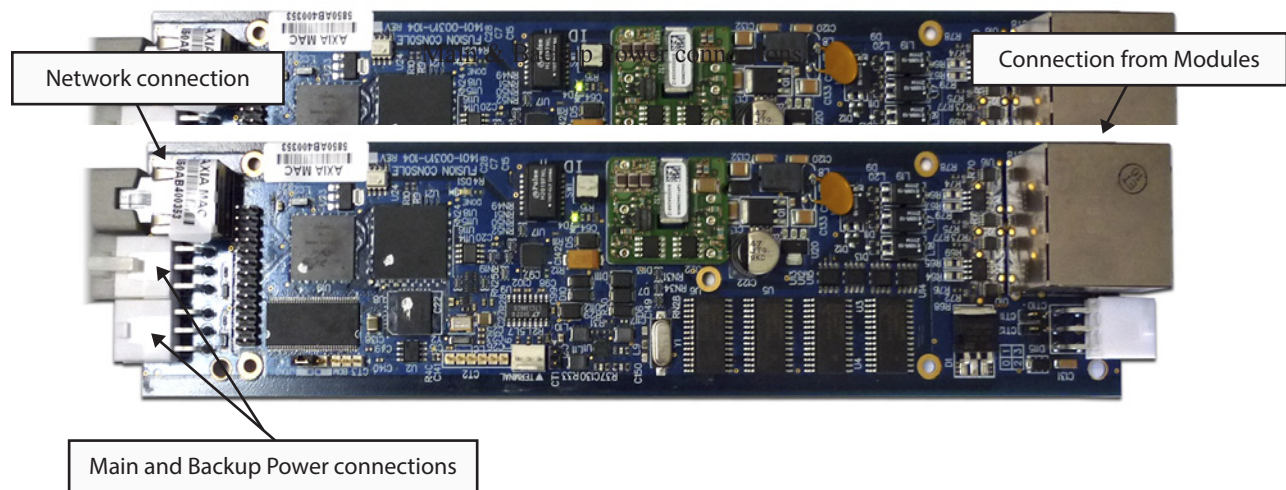

The board has a single RJ45 network port for connection to the network. Near the network port are two (2) 6-pin molex connectors for power input. The two ports provide the option to connect a redundant power supply, but only a single power connection is required to power the surface.

On the other end of the board is a four (4) port RJ45 stack; each port is an independent CANBus port. These connections are used to interface with the Fusion's installed modules. If your console has more than four modules installed (as many do), the modules themselves can be daisy-chained using the dual RJ45 connectors provided on each module.

The maximum amount of modules allowed on a single port depends on the type of modules, but the limitation is power draw. A good rule of thumb is that three modules may be daisy-chained to each of the RJ45s on the CAN4ETH board, but more may be possible — we invite you to your configuration with Axia Support if you have concerns. Typically, your console will arrive as ordered in a factory-approved configuration.

Next to the RJ45 stack is a single 6-PIN Molex terminal that is in parallel with one of the CANBus ports. This is reserved for future use; do not use this port unless specifically instructed to do so by Axia Support.

Fusion Power Supply

Fusion consoles require a 48-volts power supply to the CAN4ETH board to function.

If you are using an Axia PowerStation, this power is supplied by the Console port on the rear panel.

If you have chosen an Axia StudioEngine, a separate Axia Power Supply is required, which provides 200 Watts of power. Fusion supports redundant, auto-switching power supplies; to implement this configuration with a StudioEngine installation, you will need two Fusion power supplies.



The rear of the Axia Power Supply hosts a D-subminiature connector for 48 volts console power, and an EAC connector for AC mains power input.

Console Modules

The Fusion surface is a mixing desk of modular design. The composition of the surface consists of a console frame (which is available in multiple sizes), and an assortment of modules to suit your operational requirements.



On the underside of every Fusion module are two parallel RJ45 connectors, which connect to the console's CANBus interface using the jacks on the CAN4ETH board (as described above). These connectors provides both power and data.

Also on the underside is a rotary switch, which provides each module with a unique ID. This switch is typically set at the factory, but may be easily changed should additional modules be required for console expansion.

There are several different styles of modules: 4-Fader (S), 4-Fader (T), 2-Fader + Call Controller, Expert Monitor/Navigation module, Standard Monitor/Navigation module (which also hosts two faders), modules with Intercom functions, and User modules with programmable keys. Some of these are shown above.

What's Next

Follow on as we dive into deeper configuration territory in the following chapters.

Chapter 2:

Configuration Basics

In this chapter, we look past the Quickstart to some of the powerful tools available to you with your Fusion console — such as choosing and modifying Source Profiles, Show Profiles, and other essentials. Let's dive in!

Working With Profiles

A standard console configuration step is defining the sources that will be used on the console.

Along with declaring the audio source (giving it a friendly name), we also must define how loading the source to a fader will modify the operation of the console, and how the source in turn is modified by user interaction. Once the console has sources configured, we can go one additional step and define channel layout and monitor settings.

The Axia terminology for these source settings is “Profiles”. There are two types of profiles:

1. **Source Profiles**, which define the different audio sources and how they function within the studio system,
and
2. **Show Profiles**, which define what sources are placed on which console faders, and how the console's Monitor section is configured.

This chapter reviews some specifics of Profiles and in turn is the basic knowledge needed to configure the Fusion surface. A description on each specific option is available in the Appendixes.

Source Profiles

A good way to understand Source Profile configuration options is to jump in and build a few common sources that almost any studio would need, such as:

- **Operator Microphone** (Operator source type) – the Board Op's mic
- **Guest Microphone** (CR Guest source type) – an additional microphone in the same studio
- **CD Player** (Line source type) – any basic audio source
- **Caller** (Phone source type) – a source that would require a mix-minus return
- **Codec** with specialized return feed needs (Codec source type with custom backfeed)

Although the type and number of source profiles that need to be built at any facility differs from the next, these five samples represent the basic types of sources found in most studios; with this foundation (followed by a review of the full Source Profile options found in the Appendix), you should be able to build profiles to satisfy all of your needs.

With that, connect a computer to your Fusion’s StudioEngine or PowerStation, type its IP address into your Web browser, and follow along.

To get started, select the **Sources** link, as shown here:

The screenshot shows the Fusion (Engine80000A) Control Center web interface. On the left is a navigation menu with the following items: System, Status, Setup, Console, Sources (highlighted), Shows, Modules, CAN bus information, and Brightness control. The main content area is titled "Source Profiles:" and contains a "Create new source profile" button. Below this is a table with the following data:

	Profile Name	Type	Source
<input type="checkbox"/>	CD	Line Input	19801 <AES 1@xAES>

At the bottom right of the table area is a "Remove Selected Sources" button.

Once you’ve done this, you’ll see any sources that have already been configured, as well as to “Create new source profile” by clicking on the button at the top of the page.

Create the Operator's Mic Source Profile

The Operator's mic is intended for the operator of the Fusion console, so let's create this first.

Click **Create new source profile**. You'll see the following screen on your computer:

Source Profile:

Source type:

Source name:

Source name override:

Primary source:

Signal phase:

Signal mode for Record bus:

Fader trim gain (-25 .. 25 dB): dB Locked

Panorama position (-24 .. 24):

Processing:

Noise Gate: Threshold (-50 .. 0 dB): dB Depth (-30 .. 0 dB): dB

Compressor: Threshold (-30 .. 0 dB): dB Ratio (1:1 .. 16:1): :1 Freeze Mode

De-Esser: Threshold (-20 .. 0 dB): dB Ratio (1:1 .. 8:1): :1

Post-Processing Trim Gain (-20 .. 20 dB): dB

Equalizer:

Band:	Low (20 .. 320 Hz)	Mid (125 .. 2000 Hz)	High (1250 .. 20000 Hz)
Frequency:	<input type="text" value="25"/> Hz	<input type="text" value="1000"/> Hz	<input type="text" value="16000"/> Hz
Gain (-25 .. 15 dB):	<input type="text" value="+0.0"/> dB	<input type="text" value="+0.0"/> dB	<input type="text" value="+0.0"/> dB
Mode:	Auto	Peak	<input type="text" value="Shelf"/>

Source availability:

<input checked="" type="checkbox"/> Channel 1	<input checked="" type="checkbox"/> Channel 8
<input checked="" type="checkbox"/> Channel 2	<input type="checkbox"/> CR Monitor
<input checked="" type="checkbox"/> Channel 3	<input type="checkbox"/> St Monitor
<input checked="" type="checkbox"/> Channel 4	
<input checked="" type="checkbox"/> Channel 5	
<input checked="" type="checkbox"/> Channel 6	
<input checked="" type="checkbox"/> Channel 7	

Fader mode:

Preview mode:

Preview switching: Channel ON turns Preview OFF Preview ON turns Channel OFF

Auto-start timer: Enabled

Logic port:

Knob function:

Feed to Source:

Select "Operator" from the **Source type** drop-down list. In the **Source name** field, type a useful name, like "Host" or "Board Op", that the DJ can easily identify. This is the name that will be shown on the display at the top of fader strip the source is loaded to.

In the **Primary Source** field, enter the board mic's Channel Number. (Each audio source in the network has its own unique Channel ID number.) If you know the number, just type it in; if not, use the Browse button to the right of the field to select the source from your network.

With just these three basic options, you have enough for a working Source Profile! You could easily leave the remainder of the options at their default values, but a couple of additional adjustments will help eliminate Control Room errors.

In the Source Availability box, you have the option to control what faders and Monitor channels the source may be assigned to. Uncheck the **CR Monitor** and **ST Monitor** assignment boxes — it's not very likely you'd assign the Operator's mic directly to the monitors!

Press the **OK** button at the bottom of the page and your new Mic source is ready to use – you've just created the Operator Mic Source Profile.

NOTE: There should only be a single Operator source type loaded to the console's faders at any one time. This is because the Operator source type contains some preset logic functions specific to the type, such as muting of the Control Room (CR) monitors when the mic is open, as well as being the default source for any Talkback commands that are engaged. Therefore, any additional Microphone source should be one of the other microphone source types.

Create a Guest Mic Source Profile

The “CR guest” source type is intended for microphones located at guest positions within the same control room as the Fusion surface. The built-in logic functions will mute the CR monitors when the source is turned on, and provide GPIO logic for an optional Guest Control Panel that uses GPIO to remotely control Channel ON/OFF/MUTE and Talkback functions. The steps for setup are similar to the ones outlined in the last section.

Source Profile:

Source type: CR guest

Source name: Guest Mic1

Source name override: Show sourcename

Primary source: 5202 <MIC 2@PwrStnIO>

Signal phase: Normal

Signal mode for Record bus: Stereo

Fader trim gain (-25 .. 25 dB): +0.0 dB Locked

Panorama position (-24 .. 24): 0

Processing:

Noise Gate: Threshold (-50 .. 0 dB): +0.0 dB Depth (-30 .. 0 dB): +0.0 dB

Compressor: Threshold (-30 .. 0 dB): +0.0 dB Ratio (1:1 .. 16:1): 1.0 :1 Freeze Mode

De-Esser: Threshold (-20 .. 0 dB): +0.0 dB Ratio (1:1 .. 8:1): 1.0 :1

Post-Processing Trim Gain (-20 .. 20 dB): +0.0 dB

Equalizer:

Band:	Low (20 .. 320 Hz)	Mid (125 .. 2000 Hz)	High (1250 .. 20000 Hz)
Frequency:	25 Hz	1000 Hz	16000 Hz
Gain (-25 .. 15 dB):	+0.0 dB	+0.0 dB	+0.0 dB
Mode:	Auto	Peak	Shelf

Source availability:

<input checked="" type="checkbox"/> Channel 1	<input checked="" type="checkbox"/> Channel 8
<input checked="" type="checkbox"/> Channel 2	<input type="checkbox"/> CR Monitor
<input checked="" type="checkbox"/> Channel 3	<input type="checkbox"/> St Monitor
<input checked="" type="checkbox"/> Channel 4	
<input checked="" type="checkbox"/> Channel 5	
<input checked="" type="checkbox"/> Channel 6	
<input checked="" type="checkbox"/> Channel 7	

Fader mode: Normal

Preview mode: Pre-Fader (CUE)

Preview switching: Channel ON turns Preview OFF Preview ON turns Channel OFF

Auto-start timer: Enabled

Logic port: Exclusive mode

Knob function: PreAmp Gain Adjust

Feed to Source: Default

Default Backfeed Options:

Dim gain (-30 .. 0 dB): Enable -12.0 dB

From the **Source Type** droptown, select “CR guest” and type in a friendly name of up to 10 characters.

In the **Primary Source** field, enter the mic’s Channel Number, either by typing it in or using the Browse button to the right of the field to select the source from your network’s source list.

You can leave the rest of the options at their default settings. Press the **OK** button at the bottom of the page and you’ve just created a Guest Mic Source Profile.

Other Helpful Options: Knob Function

Pressing the **Channel Options** encoder at the top of any fader strip opens the Channel Option screen on your Fusion’s monitor; rotation of the knob then navigates you through the options available to you: selecting a different source, applying EQ or Pan/Balance settings, and other adjustments.

However, the action taken when the board operator rotates the Options knob *without* pressing it can be tailored to your studio’s preferred operating style via the setting in the Source Profile’s **Knob Function** dropdown box.

- If **PreAmp Gain Adjust** is selected, the board op will be able to use the knob to quickly boost or cut the level of the source at its Input stage to compensate for audio that’s too “hot” or too low.
- If **Fader Trim Level** is selected, the control does not affect the Input gain of the source, but simply adjusts the range of the fader itself. This is useful when one of a group of similar audio sources is higher or lower than its siblings, and the operator wants to maintain a similar physical fader position.

Other Helpful Options: Default Backfeed

The other Source Profile option that’s important to microphone sources is found in the **Default Backfeed Options** box.

In Axia parlance, “Backfeed” refers to any audio that’s sent back to an audio source (such as a microphone, codec or phone caller) from the console. When pressing the Talkback key on a fader strip, the board-op’s mic is routed, pre-fader, to the “backfeed” of that channel — an IFB function, if you will. This may be a Mix-Minus for phone or codec sources, or a private headphone feed for microphone positions.

The **Dim gain** setting defines the amount of cut, in dB, by which the Backfeed’s normal audio is adjusted, so that the board-op can be better heard in the mic-user’s headphones.

Other Mic Profile Types

In addition to the **Operator** and **CR Guest** mic profiles, several other types are provided: **CR producer**, **Studio guest**, and **External microphone** are also available.

CR producer is intended for a Show Producer’s mic loaded in the same studio as the mixing console, so its GPIO logic functions mute the CR monitors, and specialized GPIO functionality permits the producer to talk (using **Backfeeds**, Axia’s name for internal foldback, or IFB) to any source with a Backfeed that is assigned to the Preview (cue) channel.

Studio guest is used for mics located in an adjacent studio — for instance, a talk studio for stations hosting Talk formats, or a music format with a morning show crew. The **Studio guest** source type logic mutes the Studio monitor

mix when the mic is turned on, and provides GPIO logic that permits optional control panels to control ON/OFF/MUTE states, and make use of the Talkback channel to the Control Room board operator.

The **External** microphone source type is used for any microphone that will benefit from a headphone feed, and located in a space that does not require monitor speaker muting.

Create a CD Player Source (Line Source Type)

The **Line Source** type is the basic source for inputs other than microphones. It will not mute the monitor speakers when ON, and doesn't require a Backfeed (mix-minus or IFB).

Line Source is perfect for creating Source Profiles for devices such as CD players, DAT decks, Satellite receivers, PCs using standard audio outputs, etc.

Source Profile:

Source type: Line

Source name: CD Player

Source name override: Show sourcename

Primary source: 1201 <AES-1@LvAES>

Signal mode: Stereo Locked

Signal phase: Normal

Signal mode for Record bus: Stereo

Fader trim gain (-25 .. 25 dB): +0.0 dB Locked

Panorama position (-24 .. 24): 0

Source availability:

<input checked="" type="checkbox"/> Channel 1	<input checked="" type="checkbox"/> Channel 8
<input checked="" type="checkbox"/> Channel 2	<input type="checkbox"/> CR Monitor
<input checked="" type="checkbox"/> Channel 3	<input checked="" type="checkbox"/> St Monitor
<input checked="" type="checkbox"/> Channel 4	
<input checked="" type="checkbox"/> Channel 5	
<input checked="" type="checkbox"/> Channel 6	
<input checked="" type="checkbox"/> Channel 7	

Fader mode: Normal

Preview mode: Pre-Fader (CUE)

Preview switching:

- Channel ON turns Preview OFF
- Preview ON turns Channel OFF
- Enabled

Auto-start timer: Enabled

Logic port: Exclusive mode GPIO ready enabled

Knob function: Fader Trim Level

Feed to Source: Disabled

Setting up this Source Profile is just as easy as the previous two profiles.

From the **Source Type** dropdown, select “Line”. Enter a name for the device, such as “CD Player” or “CD 1”.

In the **Primary Source** field, enter the input's Channel Number, either by typing it in or using the Browse button to the right of the field to select the source from your network's source list.

Now click the **OK** button at the bottom of the screen; your CD player is configured and ready to be assigned to a fader.

Note that we left the “ST Monitor” box checked in the **Source Availability** section. Doing this allows the board op to assign the CD player to the monitors in the adjacent studio for direct auditioning.

A more practical application for this option is when creating a Source Profile for an Air Monitor, so that talent can directly monitor the over-the-air broadcast signal. To do this, you’d create a **Line** source type for the air monitor receiver, and *uncheck* all the Channel availability boxes *except* the CR Monitor and ST Monitor. This way, the over-the-air signal can feed the monitors — but *not* be assigned to a fader and sent back to the transmitter!

Another check box that’s useful for Line source types is the one marked **GPIO ready enabled**. This controls the OFF lamp on the fader strip that the source is assigned to. Some operation practices require an indication of source readiness; when this box is checked, the fader’s OFF lamp will only illuminate when the device provides a “ready” logic state.

Many professional CD players provide GPIO closures for such states, as well as most modern Automation systems, but make certain that you understand this feature prior to enabling and, that your device really does support a “Ready” indication. If it doesn’t, your operators may think the OFF lamp is broken because it never illuminates!

Create a Telephone Source (Phone Source Type)

Putting phones on-air is one of the basic operations of the modern studio. Fusion's **Phone** Source Type helps ease the task of handling outboard phone hybrids.

Source Profile:

Source type: Phone

Source name: VX Select1

Source name override: Show sourcename

Primary source: 20033 <S3:Selectable 1@Telos-V

Signal mode: Stereo Locked

Signal phase: Normal

Signal mode for Record bus: Stereo

Fader trim gain (-25 .. 25 dB): +0,0 dB Locked

Panorama position (-24 .. 24): 0

Phone Control:

No Phone Control

EU Phone:

Server IP:

Telos 2: Line:

AP (Nx12): Use 2nd show (split)
Line:
Hybrid:

Vx: Studio name:
Fixed Hybrid:

US Phone:

Call Controller 1

Hybrid:

Fixed Line:

Mashing allowed

Processing:

Noise Gate: Threshold (-50 .. 0 dB): +0,0 dB
Depth (-30 .. 0 dB): +0,0 dB

Compressor: Threshold (-30 .. 0 dB): +0,0 dB
Ratio (1:1 .. 16:1): 1.0 :1
 Freeze Mode

De-Esser: Threshold (-20 .. 0 dB): +0,0 dB
Ratio (1:1 .. 8:1): 1.0 :1

Post-Processing Trim Gain (-20 .. 20 dB): +0,0 dB

Equalizer:

Band:	Low (20 .. 320 Hz)	Mid (125 .. 2000 Hz)	High (1250 .. 20000 Hz)
Frequency:	<input type="text"/> Hz	<input type="text"/> Hz	<input type="text"/> Hz
Gain (-25 .. 15 dB):	<input type="text"/> dB	<input type="text"/> dB	<input type="text"/> dB
Mode:	Auto	Peak	Shelf

Source availability:

Channel 1 Channel 8

Channel 2 Channel 9

Channel 3 Channel 10

Channel 4 CR Monitor

Channel 5 St Monitor

Channel 6

Channel 7

Fader mode: Normal

Preview mode: Pre-Fader (CUE)

Preview switching: Channel ON turns Preview OFF
 Preview ON turns Channel OFF
 Enabled

Auto-start timer: Enabled

Logic port: Exclusive mode

Hybrid answer mode: Normal, auto answer disabled

Knob function: Fader Trim Level

Feed to Source: Default

Default Backfeed Options:

Dim gain (-30 .. 0 dB): Enable -10,0 dB

Feed Source: Auto (Program 1 / Phone)

First, select “Phone” from the **Source Type** dropdown, and some phone-specific options will appear.

In the **Source Name** field, type the name you’d like to display on the Fusion’s OLED channel display.

Now, to define the Phone controls. Select from one of the following options that best suits your studio’s phone gear:

- **No Phone Control.** This is used for Telos Hx products, or for non-network-controlled hybrids from other manufacturers. You’ll still be able to control the hybrid via Fusion’s GPIO capabilities.

To do so, scroll down to the **Hybrid Answer Mode** dropdown box near the bottom of the screen. Select either “Channel ON answer hybrid” or “Channel ON or Preview ON answers hybrid”.

In the first case, when the Phone source is assigned to a console fader strip, turning that channel ON picks up the phone. In the second case, your operator may either turn the channel ON *or* use the channel’s PREVIEW (cue) key to answer the phone.

- **EU Phone** allows you to map specific lines/hybrids from a Telos Multi-Line phone system (such as TWOx12, Nx12, Nx6 or VX) to a single fader.

The screenshot shows the 'Phone Control' configuration window. At the top, 'No Phone Control' is selected with a radio button. Below it, the 'EU Phone:' section is expanded, containing three sub-sections: 'Telos 2:', 'AP (Nx12):', and 'Vx:'. The 'Telos 2:' section has a radio button and a 'Line:' field with the value '0'. The 'AP (Nx12):' section has a checked checkbox for 'Use 2nd show (split)', a radio button, and 'Line:' and 'Hybrid:' fields both with the value '0'. The 'Vx:' section has a selected radio button, a 'Studio name:' field with 'Studio 3', and a 'Fixed Hybrid:' field with '1'. The 'Server IP:' field at the top of the EU Phone section contains '192.168.100.200'.

- In the example shown above, we’re mapping a hybrid from a VX Broadcast VoIP system, using the sections highlighted in red:
 - » Type in the IP address of the VX Server into the **Server IP** box.
 - » Select the **VX** radio button.
 - » Enter the **Studio name** configured in your VX system into the **Studio Name** box.
 - » Enter the number of the VX hybrid from the specified VX Studio into the **Fixed Hybrid** box.
 - » Note: If the Server IP has authentication requirements, the authentication syntax in the Server IP field is *username:password@IP ADDRESS*. For example, *user:test@192.168.100.200* attempts to log into the specified IP address with username *user* and password *test*.

- **US Phone** ties the Source Profile to a Telos Call Controller module installed in your Fusion console. These modules work with all modern Telos multi-line phone systems. Enter the **Hybrid** number to tell the fader which hybrid the Source Profile controls.

The final step is to define how you want to handle mix-minus. Fusion (and all Axia consoles) automatically generates mix-minus (N-1, “clean feed”) for each phone caller taken to air. To configure this, you’ll scroll to the **Default Backfeed Options** box and select the desired audio mix from the **Feed to Source** dropdown.

Nine different Manual Backfeed mixes plus an Auto smart mode are available.

The default option is **Auto**. Choosing this option eliminates manual mix-minus building by switching the source of the mix-minus based on the ON state of the fader the Phone source is loaded to. When the fader is in the OFF state, the caller hears the off-line PHONE mix. The moment the channel is turned ON, the audio feeding the caller switches to the Program 1 bus, minus the caller’s own audio.

Here are the manual options:

- **PGM-1** through **PGM-4** feed the caller the output of the selected Program bus, minus their own voice.
- **AUX A** through **AUX D** feed the caller the output of the selected Aux Send bus, minus their own voice.
- **PHONE** is a mix designed to harmonize with typical, traditional radio operations. A channel is assigned to the PHONE mix by selecting the fader strips **PGM 4** key; the PHONE mix is then created pre-fader and pre-ON/OFF, so that engaging any PGM 4 button will send the audio of that channel to the phone mix at Unity gain.

We suggest leaving the selection at its default, **Auto**, unless special circumstances dictate otherwise. No matter what you choose here, the board operator can quickly override it and select a different function, using the Options knob at the top of the fader strip.

When your setup is complete, click the **OK** button at the bottom of the screen.

Advanced Stuff: A Codec Source With Custom Backfeed

If you’ve followed along and created a Phone Source Profile as described in the previous section, creating a Profile for a codec will appear similar (minus the phone hybrid controls, of course). If the codec is bi-directional, your codec Source Profile will need a Backfeed configuration as well.

The Default Backfeed behavior of the Codec provides a mono sum to both the Left and Right channels on the return audio or named Backfeed.

However, when the Talkback key on the channel strip the codec is assigned to is pressed by the operator, the board op’s mic audio (pre-fader) is routed to only the left channel; the right channel remains unchanged.

By now, you’ll have noticed that, when you begin to create a Source Profile from scratch, all profile types have either “Disabled” or “Default” displayed in the **Feed to Source** option field.

But your operation might have needs which require a more specialized Backfeed than the Default behavior. And so we provide the “Custom” option, which allows high-level control of mix-minus behavior based on channel state logic. Here’s the section of the Source Profile which pertains to this Custom Feed to Source functionality:

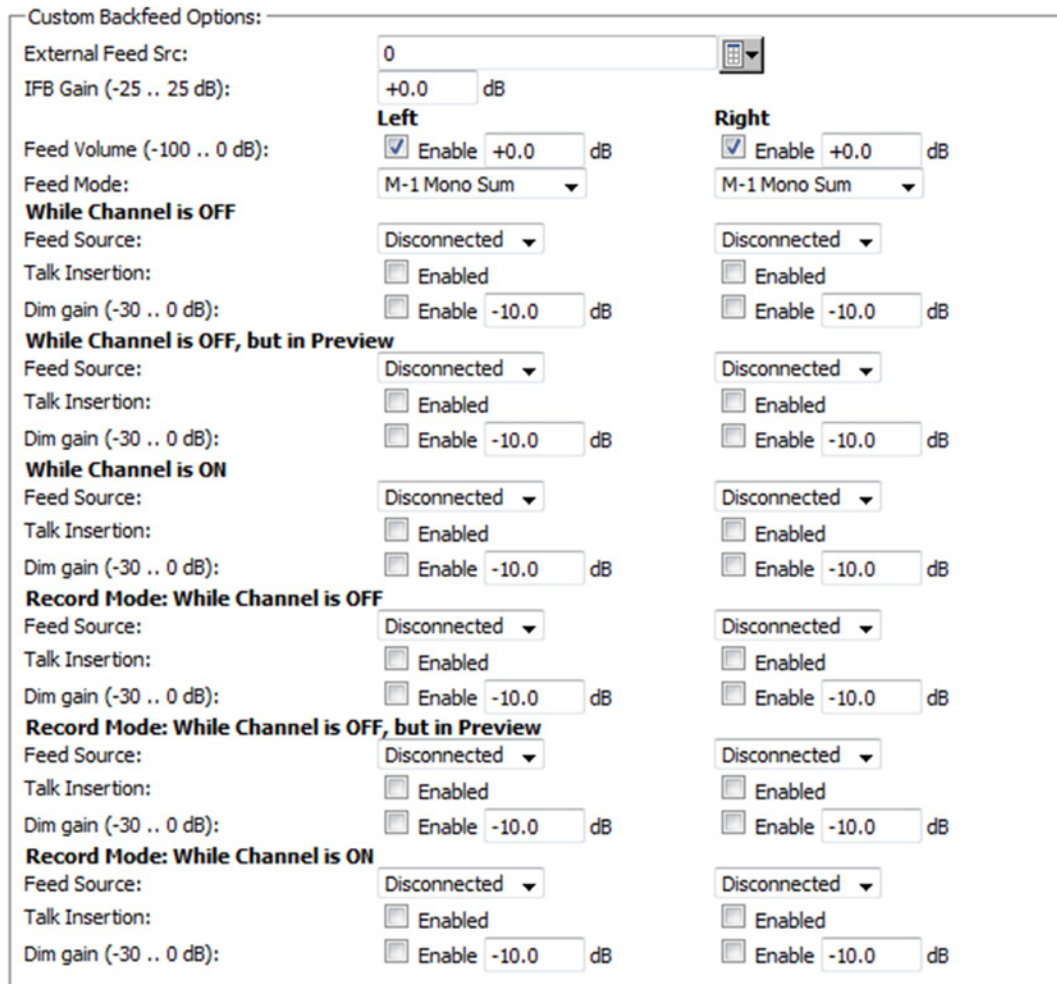

As you can see from examining, the Custom option provides significantly enhanced backfeed routing options, including independent control of the L and R sides and a completely different IFB signal insertion point.

External Feed Src allows you to pick any audio channel in your Livewire network to send to your source’s backfeed.

IFB Gain allows you to tailor the volume of the IFB audio with a cut or boost of up to 25 dB. **Feed Volume** allows you to reduce the volume by up to 100 dB for either or both sides of the stereo return channel, respectively.

Feed Mode enables you to pick from a variety of Backfeed styles.

- **M-1 Mono Sum/Left/Right** sends a mix-minus of the stereo Program output, minus the source, as either a summed Mono signal, or as the Left or Right channel of the stereo Program output, minus the source.

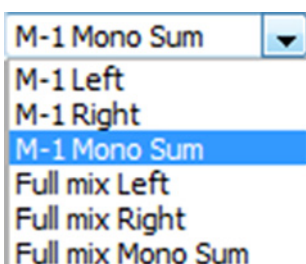

- **Full Mix Left/Right/Mono Sum** disables the Mix-Minus and supplies the complete mix to the Backfeed. You may pick the right or left channel, or choose a summed Mono signal.
- Notice that this option is active for both sides of the stereo Backfeed channel, so that you can completely customize the style of the audio flowing back to your remote user.

Next come a series of **Feed Source** options that can be applied to any or all of 6 different console fader channel states to completely customize backfeed based upon the logical state of the fader strip itself. These logical states include:

- In Standard Mode:
 - » While Channel is OFF
 - » While Channel is OFF, But in Preview
 - » While Channel is ON
- In Record Mode:
 - » Record Mode: While Channel is OFF
 - » Record Mode: While Channel is OFF, But in Preview
 - » Record Mode: While Channel is ON

Note: Record Mode is a special “macro” mode that helps talent record audio for later use with a single press of the Fusion console’s “Record” key, located on the Monitor Module. We’ll cover use of this function in later chapters.

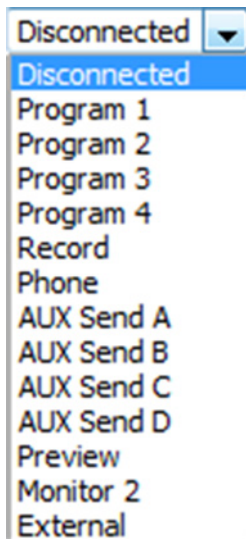

Using the **Feed Source** dropdown boxes, you can pick the Backfeed source that will be fed to the Codec’s IFB channel in each of the six possible channel states noted above. Your choices are:

- **Disconnected.** Use this when you want to disable the Backfeed (send no audio) for a particular channel state.
- **Program 1 – Program 4.** Sends the audio from the selected Program bus.
- **Record.** Sends audio from the console’s Record bus. The Record bus is a special variant of PGM4. The Record mix is postfader and pre-On/Off, to provide offline recording with volume control.

- **Phone.** Fusion has an off-line Phone bus that is actually a special variant of PGM4. The Phone bus is mono-sum, prefader and pre-on/off to allow speaker-phone style operation thru the Operator’s mic. Selecting Phone feeds the Phone bus, minus the source, so that the listener can hear other Phone callers who are waiting in the air queue.
- **Aux Send A – Aux Send D.** Sends the audio from the selected Auxiliary mixing bus.
- **Preview.** Sends the audio from any sources assigned to the Preview (cue) bus.
- **Studio Monitor.** This is the source typically sent to Guest Studio monitors & headphones by the Control Room board op. It is assigned using the “Studio Monitor” controls on the Fusion Monitor Module.
- **External.** Sends the audio from the channel you specified in the **External Feed Src.** Box at the top of the Custom Backfeed Options box.

So, say you want to construct a Custom conditional backfeed for your Codec that sends the CR Monitor when the channel is OFF, the contents of the Record bus when the channel is OFF but assigned to Preview, and a PGM-1 mix-minus when the channel is ON, you’d set it up like so:

Custom Backfeed Options:

External Feed Src: 152 <CR Headphones@LWPS80746A

IFB Gain (-25 .. 25 dB): +0.0 dB

<p>Left</p> <p>Feed Volume (-100 .. 0 dB): <input checked="" type="checkbox"/> Enable +0.0 dB</p> <p>Feed Mode: M-1 Left</p> <p>While Channel is OFF</p> <p>Feed Source: External</p> <p>Talk Insertion: <input checked="" type="checkbox"/> Enabled</p> <p>Dim gain (-30 .. 0 dB): <input type="checkbox"/> Enable -10.0 dB</p> <p>While Channel is OFF, but in Preview</p> <p>Feed Source: Record</p> <p>Talk Insertion: <input checked="" type="checkbox"/> Enabled</p> <p>Dim gain (-30 .. 0 dB): <input type="checkbox"/> Enable -10.0 dB</p> <p>While Channel is ON</p> <p>Feed Source: Program 1</p> <p>Talk Insertion: <input type="checkbox"/> Enabled</p> <p>Dim gain (-30 .. 0 dB): <input type="checkbox"/> Enable -10.0 dB</p>	<p>Right</p> <p>Feed Volume (-100 .. 0 dB): <input checked="" type="checkbox"/> Enable +0.0 dB</p> <p>Feed Mode: M-1 Right</p> <p>Feed Source: External</p> <p>Talk Insertion: <input checked="" type="checkbox"/> Enabled</p> <p>Dim gain (-30 .. 0 dB): <input type="checkbox"/> Enable -10.0 dB</p> <p>Feed Source: Record</p> <p>Talk Insertion: <input checked="" type="checkbox"/> Enabled</p> <p>Dim gain (-30 .. 0 dB): <input type="checkbox"/> Enable -10.0 dB</p> <p>Feed Source: Program 1</p> <p>Talk Insertion: <input type="checkbox"/> Enabled</p> <p>Dim gain (-30 .. 0 dB): <input type="checkbox"/> Enable -10.0 dB</p>
---	---

Naturally, this level of complexity is not necessary in every radio station, but is available for specialized situations where highly-tailored Backfeeds are required.

Show Profiles

Now that you know how Source Profiles work, let's talk about Show Profiles.

Show Profiles are, essentially, collections of Source Profiles. A Show Profile keeps track of what sources are loaded to each of your console's faders. Using Show Profiles, each user can have the board set just the way they like it — sources placed where they're most useful, monitors set to the appropriate feed, headphones conforming to personal preference.

You can also use Show Profiles to define different types of broadcasts – one for the morning show, one for talk segments, one for musical guest interviews, one for unattended operation – that instantly recall your saved configuration when loaded.

How to Create A Show Profile

The easiest way to create a Show Profile is to set up your Fusion console for a show, then save a Show Profile for it by taking a “snapshot.”

- Get started by assigning a source to each fader strip using the Options knob at the top of each fader strip, and selecting a source from the Current Source selection box.
- Once that's done, assign each source to the Program bus you want it to feed, using the PGM keys at the top of each fader strip.
- Finally, make your Monitor and Headphone audio choices using the keys on your console's Monitor Module.

Now that your console is set up the way you want, connect a computer to your Fusion's StudioEngine or PowerStation, type its IP address into your Web browser, and select the **Shows** link, as shown here:



Simply click on the **Capture show profile** link, and you'll be prompted to name your new Show Profile. Type in a name, click “OK”, and you've got a new Show Profile that can be loaded by pressing the **Profile** key at the top of your console's Monitor module.

The other link shown here, **New show profile**, allows you to construct an entire Show Profile completely from scratch using your computer's on-screen controls. This is the “expert” way of making a show profile, which allows access to settings unavailable to the console operator. We'll cover these options in detail later on.

You can save up to 99 different Show Profiles to make console reconfiguration fast and easy. Don't worry – loading a Show Profile will never take an active audio source off the air: any changes to a fader's source assignment are queued until *after* the OFF key for that fader is pressed.

Other Configuration Options

Beyond Source and Show profiles, there are some global items that allow customization of the console to your needs. In the column of links on the left hand side is the **customize** option. From this link you can configure a few global options.

User Logo:

By default the Fusion video output will show the Fusion logo, but you are free to upload your own logo which fits within the designated resolution of 331x42px.

Clock:

The Fusion display output has time information and this can be configured in various ways. By pressing the **Set time from PC** button, the system time will adjust to the time which is on the PC accessing the page. The digital clock can be set to display 24 hour time (0:00 to 23:59) or 12 hour time (AM/ PM). The second hand on the analog display clock can be set so the second hand moves either in a smooth movement or Quartz movement (default). The default behavior is where the second hand moves in steps per second. By default there is a large analog clock, but this can be adjusted so that a large digital clock is shown with a smaller analog clock. Timezone and Day Light Saving (DST) options are provided so that time can be shown for your region. If you have an NTP server on the network, you can define its IP address for the Fusion system to have time synced to the server.

GUI Settings:

The video output from the Engine or PowerStation can be set to lower resolutions. The lower resolutions provide Element style video output for Element customers to update to the latest software provided in Fusion and have display similar to what they had previously.

Loudness Meter Options:

With version 3.1, there is an added sub section to the customize option for enabling Loudness metering. Loudness metering is based on ITU.BS1770. Some of the options provided are specific to EBU R128.

The screenshot shows the 'Customize' menu on the left with 'Loudness Meter Options' selected. The settings for Loudness Metering are as follows:

- Enable Loudness Meter
 - Target Loudness:
 - Loudness Tolerance:
- Enable Relative Loudness
- Enable Color Indications
- Enable Loudness Range
- Control GPIO Channel:

A 'Save' button is located at the bottom right of the settings panel.

Enable Loudness Meter

Checking this option and pressing save will turn on loudness metering on the main display view.

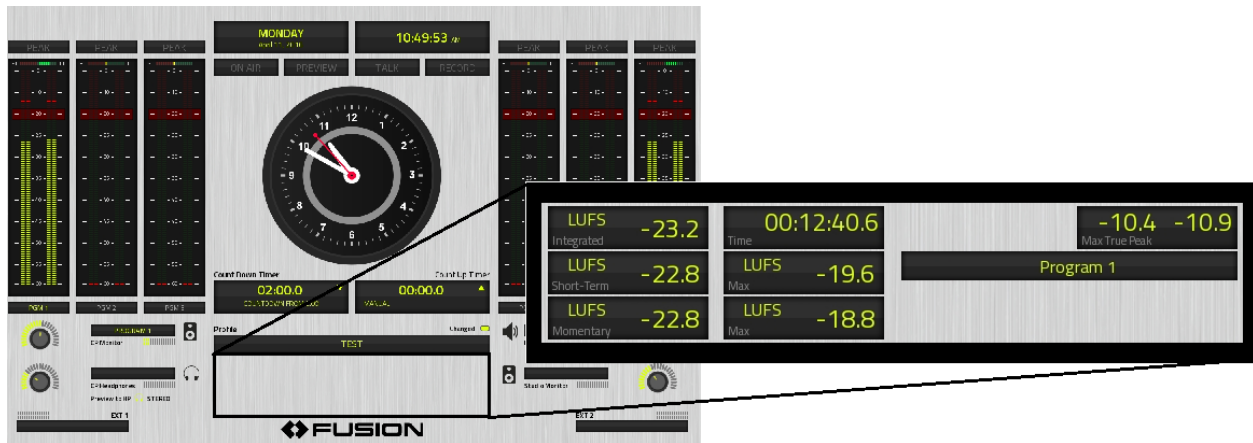

The loudness meters present numerical values for the momentary (shortest time scale of 0.4s), short (intermediate time scale, 3s), and integrated (segment-wise time scale based on timer value) scales. The maximum value recorded for momentary and short scales within the segment time is also shown. To the right of the numerical meters is the max recorded true peak values. Below the true peak meter is the measured source. The options for measured source are the various mix busses of the surface (PGM1, PGM2, etc). To select another bus to view, rotate the first encoder on the overbridge of the master module.

Target Loudness, Loudness Tolerance

Two text fields are provided for entering your desired target loudness value and the acceptable +/- deviation from that target. These fields are used for the options below the text fields. Depending on region, these values can vary. For example EBU R128 calls for -23 LUFS and the American Calm Act recommends -24 LKFS (LUFS = LKFS).

Relative Loudness

The relative loudness option changes the numerical presentation so that the number is in reference to the target. A value of 0 LU indicates the target value is achieved. Lower than target value will be negative (-) LU while positive (+) LU indicates higher than target.

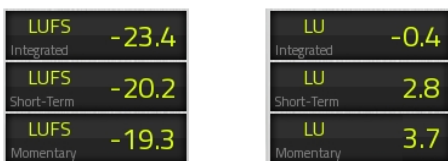

Color Indication

To have the meter change color to indicate cold, good, hot, select the *Color Indication* option and make sure the Tolerance is set appropriate. Green is an indication that the loudness is within the tolerance of the target. Red is an indication of above the tolerance value and blue is an indication of being below tolerance.



Loudness Range

Loudness range (LRA) is a supplemental measurement for loudness. It is a statistical distribution of measured loudness that quantifies the variations. The measurement is presented in LU. A typical promo would have an LRA of 5 +/-1 LU. A typical theatrical drama would have an LRA of 15 +/-1 LU.

Control

Other than enabling the loudness meter for your facility's needs, the program segment length is needed to be defined by the operator or other control point. When loudness metering is enabled, the timer control buttons are used for control of the integration timer and no longer for the count up timer. To control the up (and down) timer, press the timer option button to control the timers with the overbridge knobs. The control of integration time will be the START/STOP and RESET buttons. In addition, a GPIO channel number may be defined to provide control of the integration time from another location other than the operator.

The pinout is:

Pin	Function
1	START
2	STOP
3	RESET

Fader Options:

Fader offset allows for adjusting the gain control of the fader. For regions that wish to have 0dB gain (unity) at the fader top position, they can set the field to -10dB to offset the default values.

There is a field to define *Virtual faders* which enables channels in the DSP that are not represented in the hardware surface. Virtual faders can be defined within Show profiles and remote controlled from Pathfinder, SoftSurface or other 3rd party products.

Indication Style:

Armed fader indication is an indication style of *Fader start* function within a Source profile. In a Source profile, there is the Fader Mode options where the Fader start with Arm is one option. Fader start is where the ON/OFF state of the channel is controlled by the position of the fader. The Arm function is a hybrid approach where the ON buttons can act to enable the fader to control the state of the channel or not. The default Arm indication is a blink operation. So may prefer a solid illuminated button.

Confidence metering options allow for enabling or disabling the meter presentation on the surface.

Sound4 Remote Control:

The Omnia Voco8 is a powerful microphone processor with many option and controls. For easy recall of the presets during a show in progress, the Fusion console provides an interface to control the Voco 8 in Live mode. To setup, enter in the Server IP and the appropriate login and password.

From the console surface, press the Additional Options button on the Monitor/Navigation module or hold * + 4 + 8 keys for 5 seconds (Monitor+2 faders). This will open the control options view to the screen.

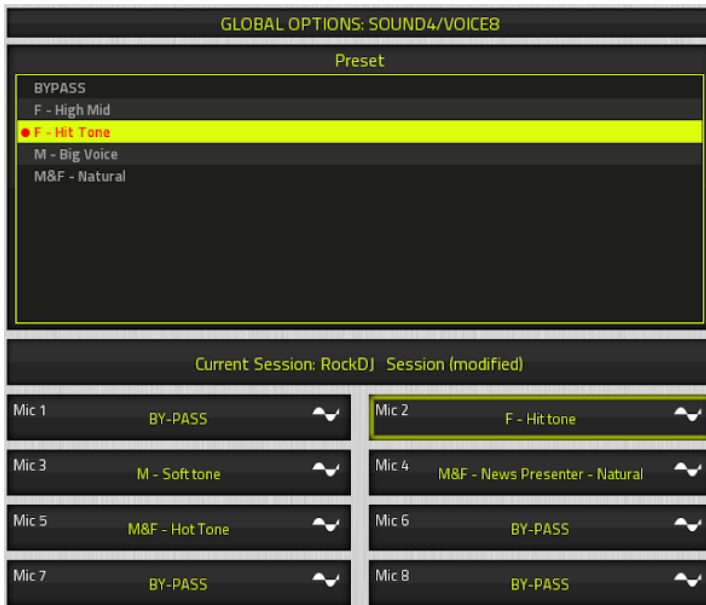

Use the first knob to highlight which item to edit. With the second knob, you select a preset to load. By pressing the 2nd knob inward, you will load the Sound4 session.

What's Next

With configuration basics covered, the next chapter moves on to Console Operations – a tutorial on the controls the board operator will use to run the Fusion console.

Intentionally Left Blank

Chapter 3:

Operation

Fusion was designed with speed in mind. On-air studios are fast-paced operations, and our design goal is for every control, display and interface to enhance your Operator's speed and accuracy.

Because different people work differently, we've made it possible to access some functions in multiple ways. This way, the board operator can work the way they want — not the way somebody else *thinks* they should work!

This chapter will start with an overview of Fusion's displays and controls to help familiarize you. Then, we'll have a look at some of the more specialized options.

Main Display

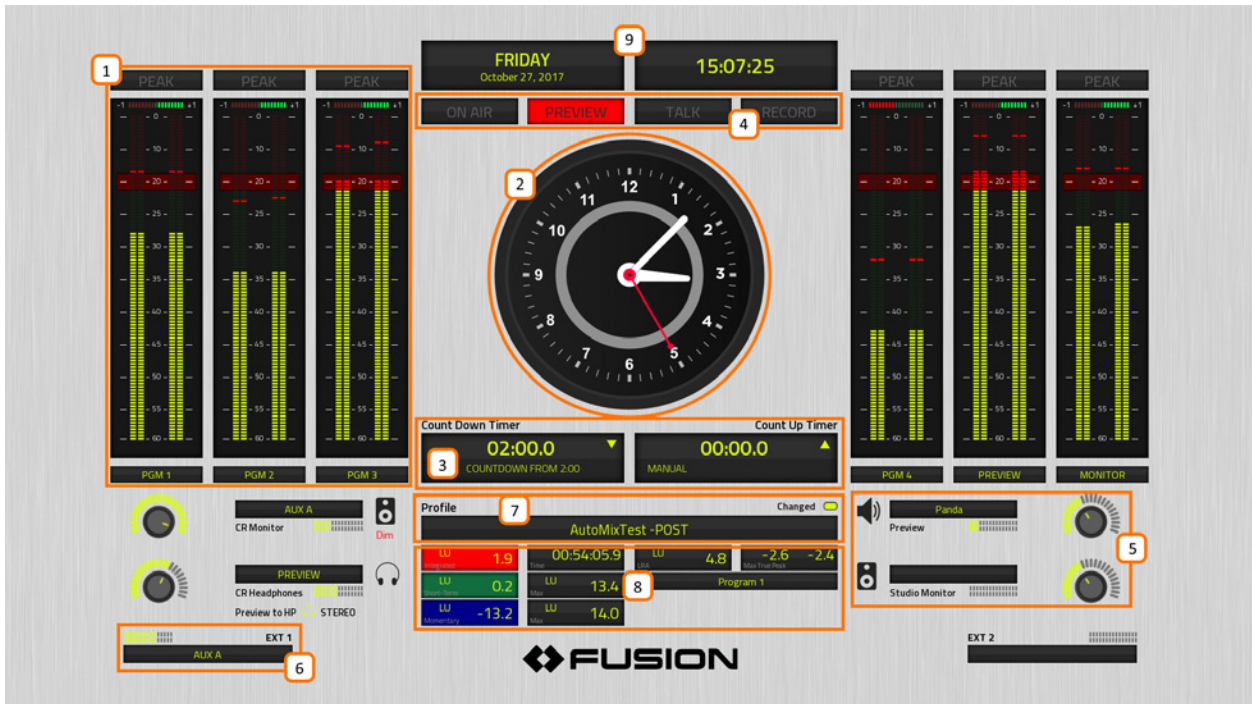

This is the main Fusion display screen. 99% of the time, this is what you'll see on your Studio display.

1. **Main Meters.** There are 6 bargraph-style meters with phase indication at top are on-screen at all times. By default, they meter the **PGM-1 – PGM-4** mixing buses, plus the **Preview (Cue)** channel and the **Monitor** feed. You can change the sources of the 3rd and 4th meters if you like.
2. **Analog-Style Clock.** This time-of-day clock can be slaved to a house NTP server. When using the built-in Count Down timer, the inner gray ring turns red to indicate seconds left until Zero.

To augment Fusion's metering capabilities during very busy programs, the Analog Clock can be replaced with 4 more meters, which can be pre-defined in Monitor Settings page of any Show Profile.

3. **Count Down / Count Up Timers.** The Count Down timer is an interval timer that counts down to Zero from any starting point set by the operator; useful for back-timing network joins or other precision programming shifts. It is manually started.

The Count Up timer is an elapsed-time timer that counts up from Zero. It can be set to start manually, or start/stopped/reset automatically based upon the ON and OFF keys on channels you've defined.

4. **Annunciator Strip** lets board ops know when Mic channels are open, when audio is being auditioned in the Preview (cue) channel, when Talkback is active in either direction, and when Fusion's one-touch Record Mode is active.

5. **Main Monitor Assignments / Confidence Meters** let ops know what sources are being heard in the Control Room and Studio Monitor and Headphone feeds, and in the Preview channel. Adjacent confidence and set-level meters display show set levels of the physical controls and incoming signals.
6. **EXT 1 / EXT 2 Confidence Meters.** These meters show the sources of audio assigned to either of the two External Monitor selection keys, and audio levels of those sources.
7. **Profile Window.** Displays the name of the active Show Profile.
8. **Loudness Meter.** Will be displayed under the Show Profile window if enabled.
9. **Day/Date/Time Displays.** Shows the current date and time in digital format.

Basic Channel Controls

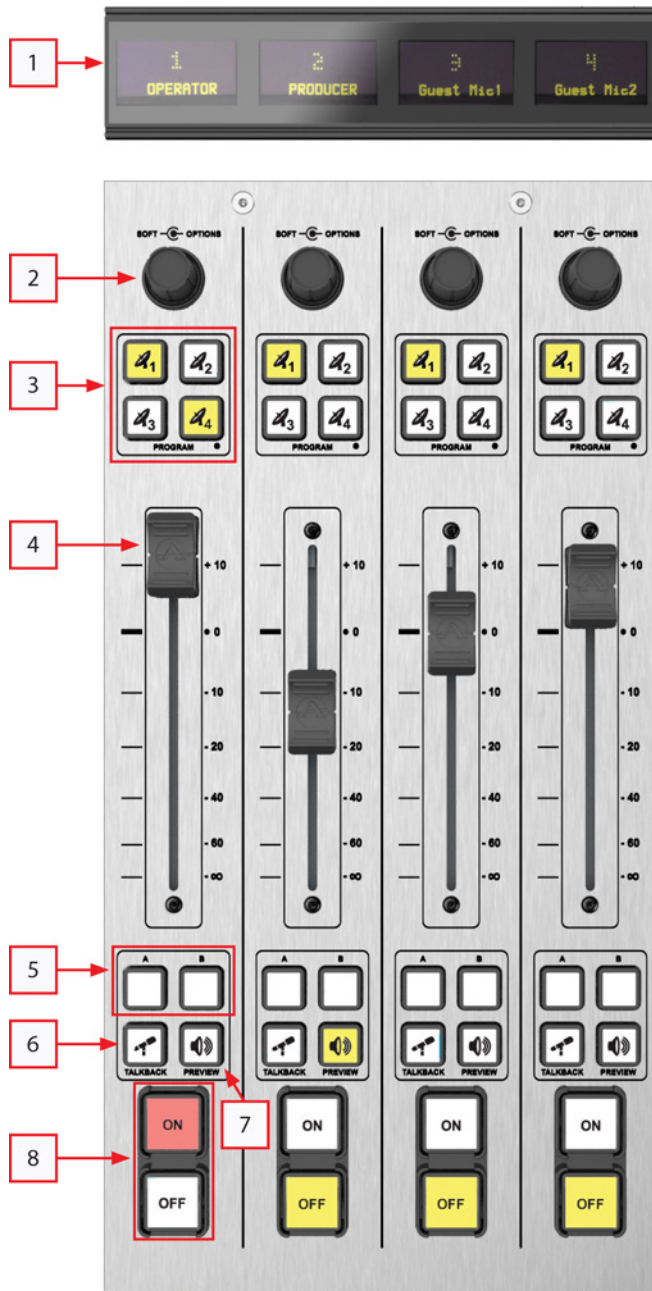

Here's the 4-Fader (S) Module, the basic building block of any Fusion console. The controls should be familiar to any radio pro:

1. **Channel Display.** This window displays the audio source assigned to the fader, plus confidence meters for incoming audio. If the operator presses the Talkback key at the bottom of the fader strip for any source with a Backfeed (mix-minus or Talkback channel), the display will note this, and supply confidence meters for the Backfeed audio too.

2. **Soft/Options Knob.** Press this knob to enter Channel Options mode and select the audio source, adjust EQ, Mic dynamics, Pan/Mode and send audio to any one of the four Aux Send buses.

Rotate the knob without pressing to adjust fader gain trim, or source Preamp gain (depending upon the preset choice).

3. **Main Bus Assignment Keys.** Quickly assign the source to any or all of the four main Program buses.

4. **Channel Fader.** You know what this does, right? Right!

5. **A/B Keys.** "Soft" keys that can be programmed to send routing or GPIO commands via Axia Pathfinder routing products.

6. **Preview Key.** Sends audio to the Preview (Cue) bus for off-air auditioning.

7. **Talkback Key.** Sends pre-fader audio from the board operator's Mic channel to an audio source that has a return audio path, such as a remote codec, Phone caller or Studio mic with a dedicated headphone feed. Used in conjunction with the Preview key, the operator can easily have an off-air conversation with remote talent or guests.

8. **ON/OFF Keys.** Turns the channel on and off.

Expert Monitor Module Controls

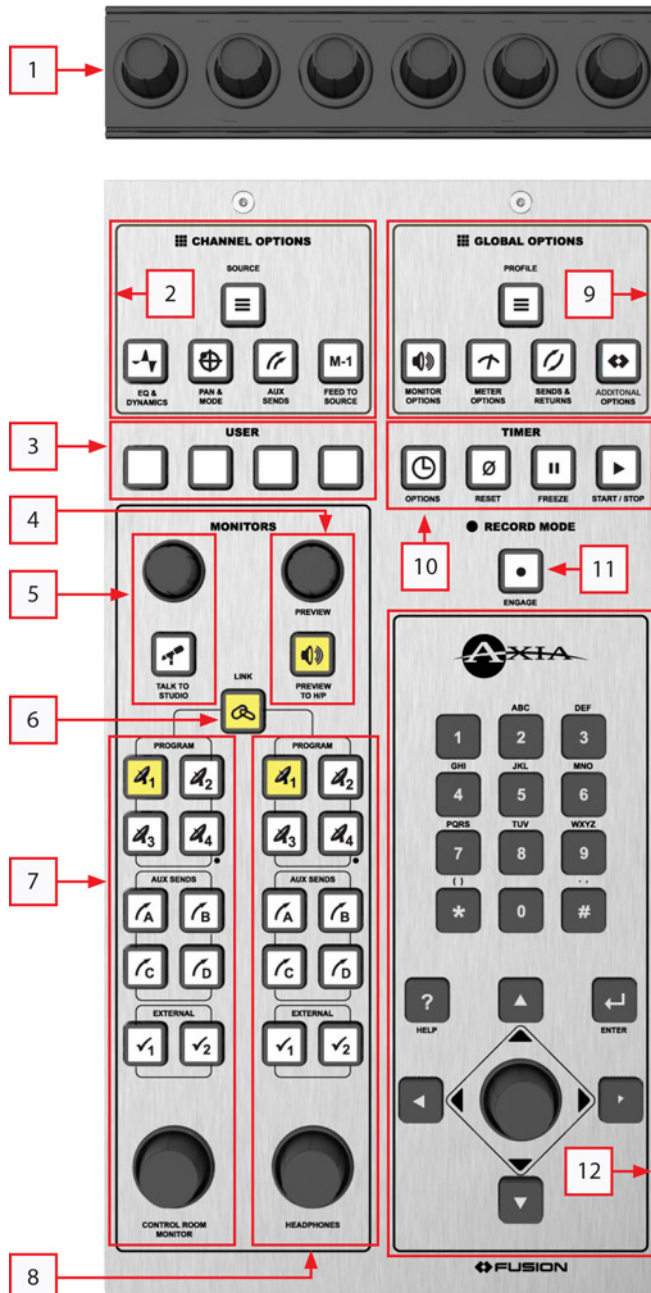

Here’s the Expert Monitor Module. This is a dual-width module with direct-access keys to every monitor and channel option function on the console.

1. **Multi-Function Knobs.** When advanced controls are active, the center clock in Fusion’s display changes to indicate the active function, and the action of each knob when pressed or rotated.

2. **Channel Options section.** When you press a **Soft/Options** knob at the top of any fader strip, pressing any of these keys takes you directly to that option.

- » **Source** lets you change the audio source assigned to the fader.

- » **EQ & Dynamics** adjusts the EQ curve and Mic compression / expansion settings (if allowed).

- » **Pan & Mode** lets you adjust pan/balance, choose Stereo or Mono signal mode, and correct signal phase issues.

- » **Aux Sends** permits assignment of the audio source to any or all of the four Aux Send buses.

- » **Feed To Source** gives the operator manual control over mix-minus feed, if present.

3. **User Keys.** “Soft” keys that can be programmed to send routing or GPIO commands via Show Profile configuration or Axia Pathfinder routing products.

4. **Preview Controls.** Adjusts the volume of the Preview (cue) speaker; turns Preview To Headphones on and off.

5. **Studio Monitor Controls.** Adjusts volume of the Studio Monitor speakers, and allows the board op to Talkback to studio guests through the Studio Monitor feed.

6. **Link Key.** When unlit, operators can choose separate sources for the CR Monitor and CR Operator Headphones. When lit, the same audio is fed to CR Monitors and Headphones.

7. **Control Room Monitor controls.** Choose any of the four Program buses, four Aux Sends or two External sources to feed the CR Monitor speakers. Sources assigned to External keys are set in Show Profile, but pressing either key for 5 seconds allows the operator to change the sources assigned to the External key on-the-fly.
8. **Control Room Headphone controls.** Same controls as provided for the CR Monitor speakers, but affects CR Headphone feed.
9. **Global Options section.** Unlike Channel Options keys (which affect an active fader strip), Global Options affect the entire console.
 - » **Profile** displays the entire list of pre-saved Show Profiles that the operator can load. Press once to display the list; press-and-hold to restore the active Show Profile to its “saved” state after changes have been made.
 - » **Monitor Options** let the board op adjust Talkback gain in monitors, built-in Headphone Processing settings, and choose Stereo or Mono monitor modes.
 - » **Meter Options** lets the operator choose meter ballistics, and activate the “More Meters” display of up to 4 additional onscreen meters, whose sources preset by the Engineer.
 - » **Sends & Returns** key lets operator adjust the master volume of Fusion’s four Aux Send buses, and volume and Program bus assignments of the two Aux Return buses. Press once to work with Sends, twice for Returns.
 - » **Additional Options:** Reserved for future expansion, such as Voco8 control. Pressing this button will open options if enabled on the software.
10. **Timer controls.** Affects options of the Count Down and Count Up onscreen timers.
 - » **Start/Stop, Freeze and Reset** control the actions of the Count Up timer.
 - » **Options** lets the operator adjust the duration of the Count Down timer, and begin its countdown. You can also switch the Count Up timer between Manual, Auto Reset and Auto-Add modes.
11. **Record Mode Key.** Puts the console into “Record Mode” – a macro function defined in each Show Profile. Activating Record Mode allows changing control room and studio Monitor and Headphone sources to pre-defined bus selections, start and stop an associated recording device, and change meter options, easing on-the-fly off-air recording of phone callers or remote talent. Pressing once invokes Record Mode; a second press returns the console to its previous state.
12. **Keypad and Nav Controls.** At the bottom right of the Expert monitor module is a Control Knob surrounded by a set of navigation keys (Up, Down, Right and Left), an Enter key, and a Help key. These controls provide an alternative to the Multi-Function knobs for navigating Fusion option screens. Operators can use the directional keys to navigate through on-screen lists, and the Enter key to “take” a selection. The Control Knob can also be used to scroll through on-screen lists. The keypad is used for dialing Telos phone systems or Codecs attached to the Livewire network.

Standard Monitor Module Controls

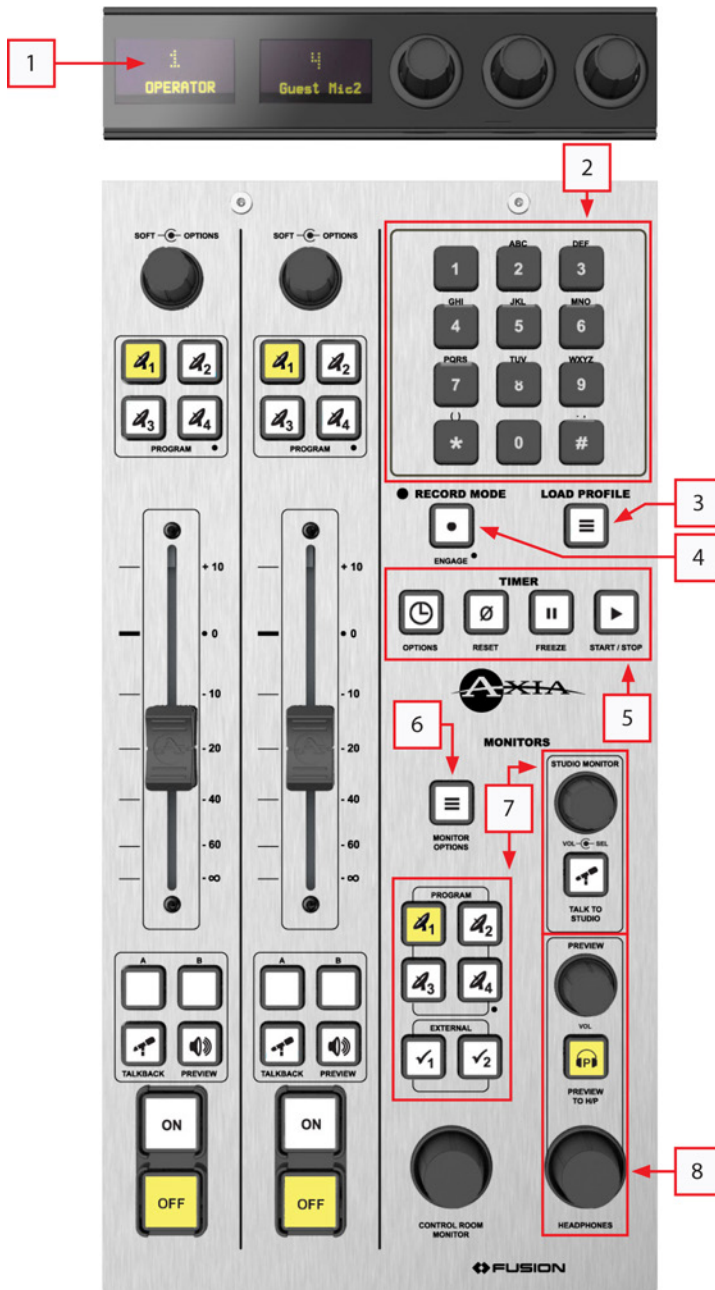

For studios where expert monitor controls are not needed, the Standard Monitor Module is a space-saving design that incorporates two faders in addition to the numeric entry/dial pad and basic Monitor/Headphone controls.

1. **Channel Display and Multi-Function Knobs.** Contains displays for faders, plus knobs that can be pressed or rotated to change options when advanced functions are active.
2. **Numeric Entry Keypad.** The keypad is used for dialing Telos phone systems or Codecs attached to the Livewire network.
3. **Profile Key.** Displays the entire list of pre-saved Show Profiles that the operator can load. Press once to display the list; press-and-hold to restore the active Show Profile to its “saved” state after changes have been made.
4. **Record Mode Key.** Puts the console into “Record Mode” – a macro function defined in each Show Profile. Activating Record Mode allows changing control room and studio Monitor and Headphone sources to pre-defined bus selections, start and stop an associated recording device, and change meter options, easing on-the-fly off-air recording of phone callers or remote talent. Pressing once invokes Record Mode; a second press returns the console to its previous state.

5. **Timer controls.** Affects options of the Count Down and Count Up onscreen timers.

6. **Monitor Options Key.** Pressing this key once allows the operator to adjust Monitor and Headphone behavior using the Multi-Function Knobs; pressing the key twice gives access to Meter Options. Settings include:

- » Adjustment of the Monitor Talkback and Dim levels.
- » Dynamics processing for the Headphone feed.
- » Whether the Preview channel is fed to a single headphone channel, both channels, or not at all.
- » Monitor Mode: Stereo, Left, Right, or Summed.
- » Meter Ballistics and Peak Display options.
- » Aux Send and Aux Return assignments and level controls.

7. **Control Room and Studio Monitor controls.**

- » **Control Room Monitor controls** allow the operator to choose any of the four Program buses, four Aux Sends or two External sources to feed the CR Monitor speakers. Sources assigned to External keys are set in Show Profile, but pressing either key for 5 seconds allows the operator to change the sources assigned to the External key on-the-fly.
- » Rotating the **Studio Monitor knob** allows the operator to control the volume of the speakers in the associated studio. Pressing the knob allows the board op to select the source feeding those speakers.
- » Pressing **Talk To Studio** allows the board op to Talkback to studio guests through the Studio Monitor feed.

8. **Preview and Headphones Controls.**

- » The **Preview knob** adjusts the volume of the Preview (cue) speaker.
- » The **Preview to HP key** turns Preview To Headphones on and off.
- » Rotating the **Headphones knob** varies the volume of the studio Headphone feed.

Call Controller + 2-Fader Phone Module



This module integrates control of Telos Hx6, Nx12, Nx6, TWOX12, Series 2101 and VX telephone systems right into the console, and features an integrated Telos Status Symbols™ to give instant information about and control over incoming phone calls.

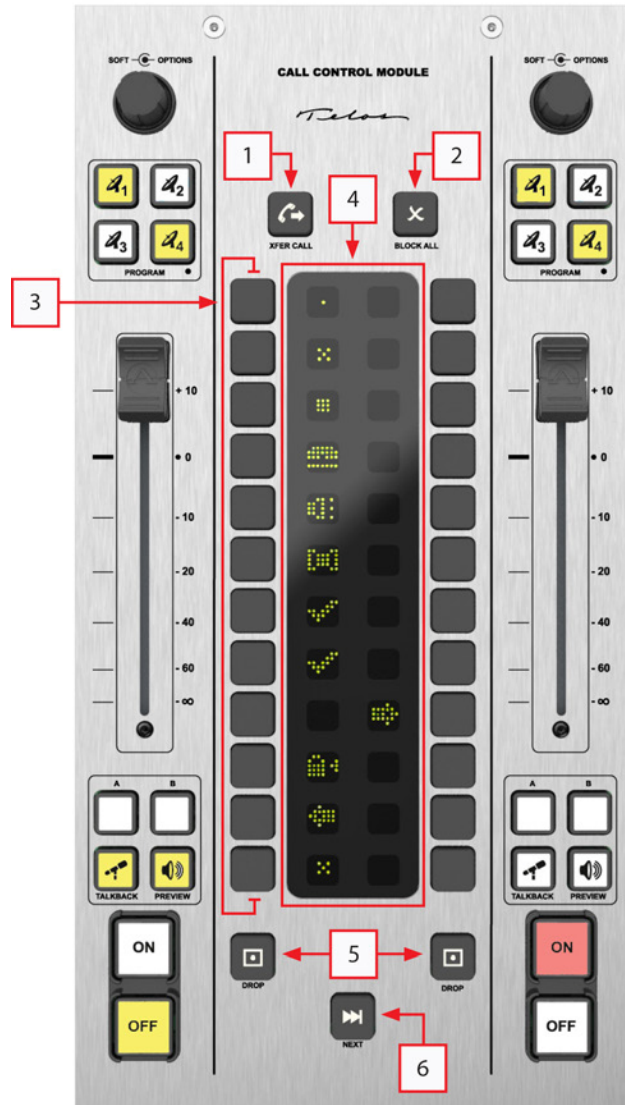

All fader strip controls operate the same way as described previously for the 4-Fader Module, so let's look at the phone-specific controls, which mimic the functions of standalone Call Controller and VSet phone controllers used with your Telos phone system.

1. **Xfer Call key** lets the board operator transfer a call from the Fusion Phone module to a local handset for off-console control or off-air conversations.
2. **Block All key** “busies out” all inactive phone lines, blocking incoming calls in preparation for on-air contesting.
3. **Line Selection Keys.** There are two columns of keys flanking the Status Symbols display; each column controls a separate phone system hybrid (for phone systems so equipped). Pressing a key “takes” the adjacent line; that line can then be screened, placed in a queue, dropped or transferred off-console. Refer to your Telos phone system Operation Manual for the specifics of how these controls work.
4. **Status Symbol display.** These symbols are visual representations of line and caller status. Refer to your Telos phone system Operation Manual for the meaning of these displays.
5. **Drop Keys.** When a line is activated using the Line Selection keys, pressing this key disconnects the selected line. One Drop key is provided per hybrid.
6. **Next Key.** When a show producer has established an On-Air Queue using their Telos phone controls or software, pressing the Next key automatically drops the current call and takes the next queued call to air.

IP Intercom Module – 20-Station



This module provides on-console integration with the Axia IP Intercom system, and gives access to 20 preprogrammed intercom stations, plus dial-up access to stations systemwide that have not been programmed to one of the speed-dial stations. The Operator’s mic is used as the local talk source; the Preview (cue) speaker is used to listen to other stations.

1. **Preset Station Displays** show what preset Intercom stations are assigned; useful for frequently-called stations. Each display provides info for two stations; associated Talk and Listen keys are above and below each display.
2. **Talk key.** Press to talk to the station indicated by the display. The adjacent LED tally illuminates when the Talk key is pressed, or when the station at the other end is listening to you.
3. **Listen key.** Press to listen to the station indicated by the display. The adjacent LED tally illuminates when you are listening to the far-end station. If this tally blinks, you must press it to allow the calling station to talk to you.
4. **Non-Preset Station Display and Talk/Listen Controls.** This display and Talk/Listen controls are used to “dial up” stations not assigned to one of the 20 presets below. To select a station to call, use the Select knob below.
5. **Non-Preset Station Selectors and Group Call key.**
 - » Rotate the **Select knob** to scroll through a list of available Intercom stations on the overbridge display above.
 - » Tap the **Assign key** to assign the selected station to the overbridge Talk and Listen keys.
 - » Tap the **Group Call key** to call multiple stations with a single button press. Please refer to the IP Intercom User Guide for details on how to use this function.
6. **Mic and Speaker Mute keys,** and Volume control.

- » Press the **Mute Mic key** to mute the Operator’s mic feed to the IP Intercom system. The LED tally will light when active.
- » Press the **Mute Speaker key** to mute IP Intercom calls to your console. The LED tally will light when active.
- » Rotate the **Volume knob** to adjust the level of incoming Intercom calls.

IP Intercom Module – 10-Station Filmcap



The 10-Station IP Intercom module gives access to 10 pre-set Intercom stations. As with the 20-Station module, the Operator’s mic is used as the local talk source; the Preview (cue) speaker is used to listen to other stations.

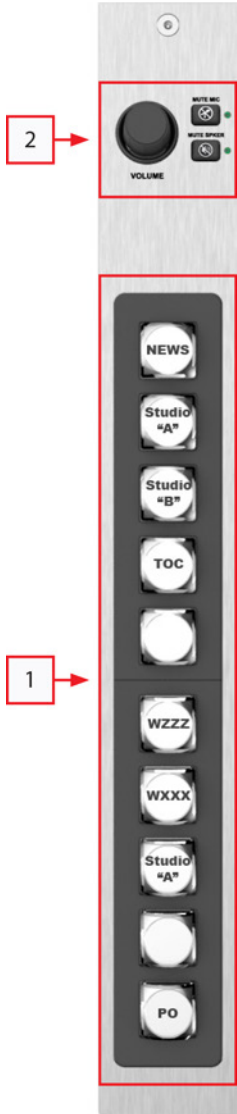

1. **Preset Station keys.** These stations are set by the Engineer, and the buttons labeled with the appropriate station name. Press to talk, release to stop talking.

2. **Mic and Speaker Mute keys, and Volume control.**

» Press the **Mute Mic** key to mute the Operator’s mic feed to the IP Intercom system. The LED tally will light when active.

» Press the **Mute Speaker** key to mute IP Intercom calls to your console. The LED tally will light when active.

» Rotate the **Volume knob** to adjust the level of incoming Intercom calls.

Switch Modules (not shown)

Fusion modules that provide remote control of studio devices and audio routing functions are available. They are programmed for specific functions by the studio engineer.

- Film-Cap Switch Modules are pre-programmed to send closures to studio devices; useful for starting and stopping recorders or sending routing activation closures to Axia PathfinderPC routing tools. One function per key is available.
- SmartSwitch Modules have color screens built into each keycap, and can dynamically display text and change color to indicate changing functions. These can be programmed with “pages” of functions to offer many more functions than just the 10 keys available. They may also be programmed as context-sensitive controls for routing salvos using PathfinderPC.

What’s Next

In the next chapter, we’ll learn about the use of Fusion’s powerful Virtual Mixer (VMix) capabilities, which allow you to create custom mixes of networked sources and use them like you would a single audio source. We’ll also look at Virtual Mode (VMode) functions, which allows you to manipulate incoming sources in many useful ways.

Intentionally Left Blank

Chapter 4:

VMix and VMode

There's a lot of DSP processing horsepower in Axia mixing engines. Rather than let that go to waste, we've used it to power two tools that many broadcasters have found to be indispensable: VMix and VMode.

VMix (short for Virtual Mixer) provides up to 16 channels of “virtual mixing”, which can be used to pre-mix up to 5 audio sources each for presentation on a single physical fader (or software fader, if Axia SoftSurface soft-console software is used). VMix works completely independently of the Fusion surface. In addition to static control of VMix through its web pages, Axia's Pathfinder routing control tools can also be used to dynamically control VMix and create mixing functions based on a variety of system-wide parameters.

VMode (short for Virtual Mode) can be used to convert channel count, channel order, and/or channel content between audio streams at its input and output. For example, passing some channels while cutting others, summing stereo to mono, upmixing or downmixing between stereo and multi-channel, combining channels from two inputs into one output. Select audio as input, define the “Mode” (conversion type, or in other words, the routing within an internal matrix), and define the output as a network source into the AoIP network. There are 16 VMode instances in a Fusion engine.

Virtual Mixing with VMix

What's it all about?

In addition to the regular mixing capabilities of your Fusion console, there is an 80-input “virtual” mixer accessed using the console's HTTP interface (or with PathfinderPC routing tools).

This mixer consists of 80 stereo input channels, a direct output for each channel, 16 submixer outputs, and one master out. The 80 channels are divided equally among the 16 subgroups, providing 5 stereo channels feeding each subgroup mixer.

The various VMix outputs described above are sources that can feed your Livewire network and they can be manipulated in the same manner as any other audio source. A VMix source can be applied to a console fader, assigned to an audio node destination, or monitored by Pathfinder.

To understand this concept, think of VMix as a standalone piece of hardware. If you visualize wiring an external line mixer to your network, Livewire audio sources would be connected to the mixer inputs; your VMix outputs then become mixdowns that you can use anywhere else on the network, just like any other audio source.

To access VMix setup, open a browser on a computer connected to your Axia network and browse to the IP Address assigned to your PowerStation or StudioEngine or, if you have Axia iProbe, open the UI page by right-clicking on the device's icon in the left pane. Then, choose the **V-Mixer and V-Mode** item from the navigation bar.

The following image is an excerpt of the VMix/VMode setup screen. It shows the VMix Main and Sub-Mixer 1 controls. These sub-mix controls are duplicated for all 16 VMix submixers.

Note that adjustments made to VMix take effect as soon as you apply them — so changes saved “on the fly” will affect your output streams immediately.

Virtual Mixer													
Src Name:	Channel (1..32768):	In Stream Type:	Status/ Audio:	Enable:	Gain (dB): (-80.0..10.0)	Out Name:	Channel (1..32767):	Out Stream Type:	Status/ Audio:				
						VMIX Main	14319	Disabled	<input type="checkbox"/>				
Apply													
						Submix 1:	-80.0	VMIX 1 Sub	14320	Live Stereo	<input type="checkbox"/>	OK	<input type="checkbox"/>
1-1	Preview	11113	From source	<input type="checkbox"/> OK	<input type="radio"/> Off <input type="radio"/> On	-38.0	VMIX 1 fader 1	14321	Disabled	<input type="checkbox"/>	<input type="checkbox"/>		
						Fade time:	5	.5	(0.0..60.0 sec)				
1-2	Studio 2 Mic 4	1014	From source	<input type="checkbox"/> OK	<input type="radio"/> Off <input checked="" type="radio"/> On	-33.3	VMIX 1 fader 2	14322	Disabled	<input type="checkbox"/>	<input type="checkbox"/>		
						Fade time:	5	.5	(0.0..60.0 sec)				
1-3	VMIX 6 fader 2	14352	From source	<input type="checkbox"/> OK	<input type="radio"/> Off <input checked="" type="radio"/> On	-25.7	VMIX 1 fader 3	14323	Disabled	<input type="checkbox"/>	<input type="checkbox"/>		
						Fade time:	5	.5	(0.0..60.0 sec)				
1-4	TV	1028	From source	<input type="checkbox"/> OK	<input type="radio"/> Off <input checked="" type="radio"/> On	-14.7	VMIX 1 fader 4	14324	Disabled	<input type="checkbox"/>	<input type="checkbox"/>		
						Fade time:	5	.5	(0.0..60.0 sec)				
1-5	Pgm 1	12001	From source	<input type="checkbox"/> OK	<input type="radio"/> Off <input checked="" type="radio"/> On	-6.7	VMIX 1 fader 5	14325	Disabled	<input type="checkbox"/>	<input type="checkbox"/>		
						Fade time:	5	.5	(0.0..60.0 sec)				
Apply													

VMix Main Controls

The **VMix Main** output provides a summed mix of all 16 submixes. Unless you need a single output that combines the audio from of all the submixes, you may leave this disabled — it doesn’t need to be enabled for the submixers to work. There are only a few settings for this control:

- **Out Name.** You can enter a friendly name for the VMix Main output, which will be displayed as a source name on your Axia network.
- **Out Stream Type.** Choose from **Live Stereo**, **Standard Stereo**, or leave it **Disabled** if no Main stream is desired.
- The **Status** window will normally display “OK” when the stream is enabled.
- The **Audio** box will be green when audio is present.

VMix Submixer Controls

In most cases, the VMix Subs are the only channels you will need to enable, since each Sub has its own direct output. Only enable Submixes you intend to actively use; active submixes without any activity clutter up your network with empty streams.

First, you’ll want to enable the Submixer you’re working with. At the top of the section, you’ll see (in this case) **Submix 1** displayed on the screen. Next to that are controls for:

- **Gain.** Set this at whatever output level you want the submix output stream volume to be.
- **Channel.** All Livewire audio streams are assigned a Channel number; put a unique value in this box.
- **Out Stream Type.** Choose from **Live Stereo**, or **Standard Stereo**. **Disabled** turns off the submixer.

Each **VMix Sub** submixer input includes an on/off setting, a gain setting, and automatic fade-up/fade-down time parameters. Using one is easy; let's walk through the steps:

- In the **Src Name** box, enter the name of the source you'll be assigning to the input.
- In the **Channel** box, enter the unique Livewire channel number of your audio source.
- **In Stream Type** will normally be set to "From Source", meaning that the source itself (a mic, CD player, etc.) will be providing the audio. However, you can select "To Source" to use the source's automatically generated Backfeed (mix-minus audio) as in input.

Example: Selecting "From Source" when a phone hybrid is assigned as a VMix Sub input would use the caller audio; selecting "To Source" would instead use the Mix Minus sent to the hybrid.

- Select the **Enable** box next to the input to turn the Submixer input on.
- Leave the **Fade Time** boxes set at their default.

The **Fade Time** function won't be used in normal operation, but can be used to create cross fades between sources when Pathfinder is dynamically making changes to the VMix.

If, say, 1.0 is entered in the first box, the submixer channel's audio will rise from $-\infty$ to the **Gain** value set in the next field in 1.0 seconds. If the field is set to 0, the audio will simply turn on at the gain value specified.

The second box works the same way, but controls the ON to OFF fade time.

- In the **Gain** box, enter the setting, in dB, that you want for the Submixer input. Each input has its own individual Gain setting.

That's all you need to do to configure a VMix Submixer input stream. You can configure up to 5 input streams per VMix Submixer.

At the bottom of each of the submix sections is an **Apply** button. Any changes you make will be saved when this button is pressed. Be sure to save the changes for each submixer as they are configured.

VMix Submixer Advanced Options

There are some additional options provided for advanced users.

In most cases only the Submix output itself needs a unique channel number, but if you so desire, each VMix input can also be sent back to the network as a unique source, post the ON/OFF and gain stage of the VMix. Some users find this useful for constructing "cascaded" mix channels to suit unique situations. To do so, enter values for these controls:

- **Out Name:** The name you give the post-on/off submix channel to send back to the Axia network.
- **Channel:** the channel number you assign to the post-on/off submix channel to send back to the Axia network.

- **Out Stream Type.** Choose from **Live Stereo**, **Standard Stereo** to enable the direct output stream for this VMix “fader”. **Disabled** means no stream will be generated.

Be sure to click **Apply** after you’ve finished making any options changes.

Some VMix Examples

Now that you know how to enable and set up VMix submixers, what might you do with it? Here are some examples.

A Mix of Sources to Monitor

Some facilities may need to monitor one or more sources in addition to program audio, like the “squawk channel” some satellite feed providers use to relay announcements.

If you wanted to monitor this “squawk” audio on your Preview speaker without taking up a fader assignment, you could create a mix of the “squawk” source and the Preview mix from the engine. The VMix Sub Channel would be the audio source that you would route to the Preview speaker.

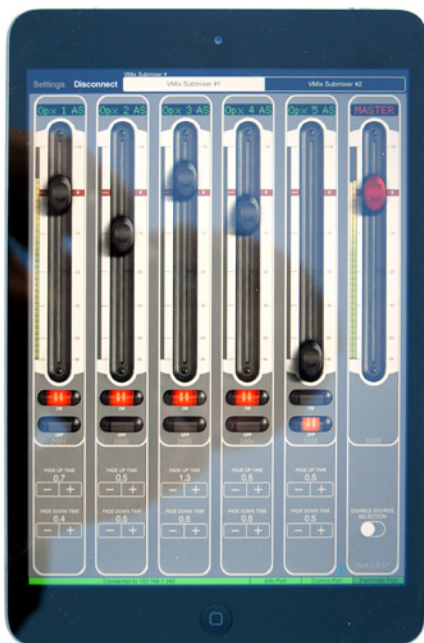

Virtual VMix Control

Using third-party products like VMix from BSI, or by taking direct control of a console’s mixing engine with Axia SmartSurface software, VMix channels can be assigned to a “virtual control surface”, giving studio talent or a producer direct control of VMix without the need for a physical console.

Combining VMix with Pathfinder Routing Control

Axia Pathfinder routing tools can be used to “control” VMix in two different modes.

First, as a background controller, Pathfinder can monitor Livewire system parameters or receive commands from external devices like satellites, button panels, or automation systems and react to them by changing the state of VMIX ON/OFF, Gain, Time Up, and/ or Time Down fields. This provides many different possibilities for facility automation, Intercom functions, or whatever else you might imagine. For example, the combo of Pathfinder and VMix could duplicate the function provided by other products that are controlling audio switching in many radio facilities. (Refer to documentation on Pathfinder for further information.)

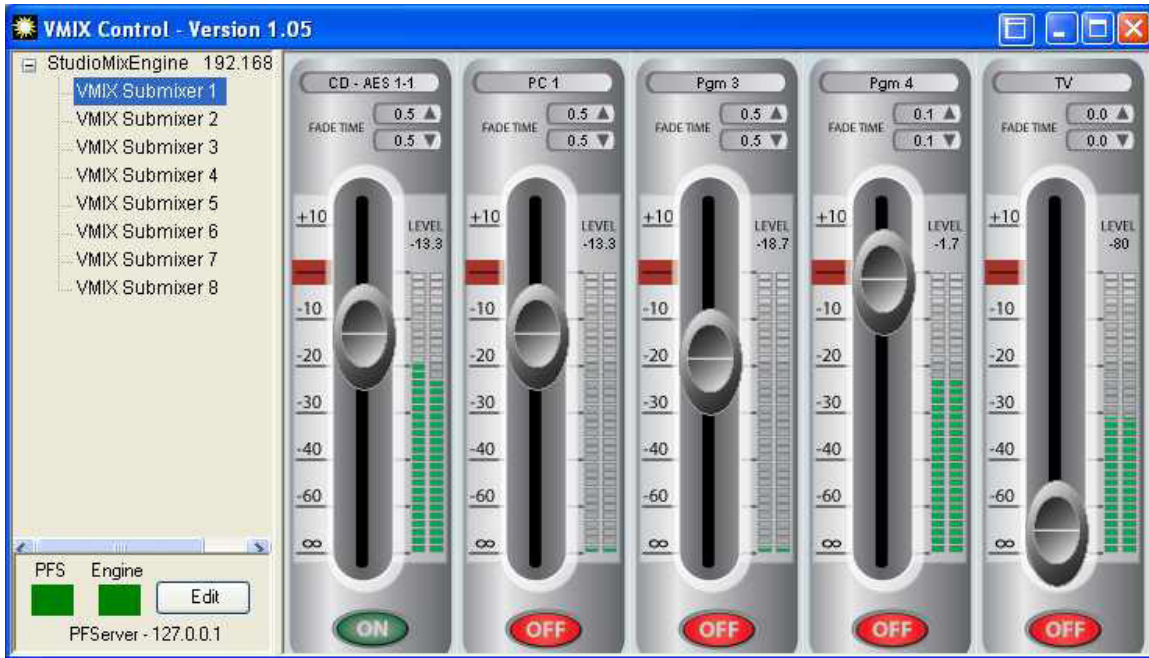

Second, there's Pathfinder's VMix Control feature. This is a software fader control option that is provided with the PRO versions of Pathfinder. VMix Control brings the operation of VMIX out of the background and provides a graphical user interface with software faders, as shown here.

There are several other ways that Pathfinder can be used for background control of VMix. VMix functions can be used both as qualifiers and actions in routing salvos. This means that a designer can select GPIO triggers, time based events, user button pushes, serial port commands, and other options and combinations of options to decide when to make changes to any Virtual Fader in a VMix. The user can make a gain change based on these events, turn a channel off or on, and or adjust the fade times, giving complete control over the VMIXer based on any of the stacking events qualifiers.

Finally, Pathfinder's Software Authority protocol translator includes commands to control any VMix fader that's active, so any machine that can send user defined serial or TCP commands can also control and read VMix functions through Pathfinder.

Using these techniques VMIX can be used as a fully automated virtual mixer in the background of each console.

GPIO control of your VMIX with Pathfinder

Imagine that you have a night jock that *should* monitor all four radio stations in your cluster. To help make sure this actually happens, you could send all four off-air signals as sources into a VMix submixer, and take the output of that submix to a monitor. A Fusion accessory panel or external button wired to a GPIO port could then provide a "press and hold" function to allow the jock to monitor the sources momentarily. (This example is only possible with Pathfinder control of VMix.)

Manipulating Streams With VMode

Each of the 16 VMode instances supports audio streams with up to 8 channels at input and up to 8 channels at output. Between the input and output, there is a matrix, where the conversion is performed, according to the selected audio routing option (“Mode”). Livewire 8-channel streams carry 5.1 content in channels 1-6, and stereo content in channels 7 and 8, and the matrix is partitioned the same way, to fit them natively:

- Channels 1 to 6 of the matrix form a multi-channel part
- Channels 7 and 8 of the matrix form a stereo part

Routing option (“Mode”) names refer to the parts of the matrix and conversions performed between them. They do not refer to channel maps of the input/output streams.

For receiving and transmitting, two stream classes are distinguished:

- Class “mono/stereo”: streams with 1 or 2 channels
- Class “multi-channel”: streams with 3 to 8 channels

Input streams put their content into, and output streams take their content from the stereo or multi-channel parts of the matrix, according to their mono/stereo or multi-channel classes. Multi-channel streams with 7 and 8 channels span across the both parts of the matrix, starting from channel 1, in the natural order. Livewire 8-channel “Surround” streams fit the matrix mapping without reordering.

The VMode view provides status of the current configuration.

V-Mode									
Input Selector	Src Name:	Address	Status/Audio	Audio Mode:	Out Name:	Address	Status/Audio		
None				Pass stereo	V-Mode 1	401			Configure...
None				Pass stereo	V-Mode 2	402			Configure...
None				Pass stereo	V-Mode 3	403			Configure...
None				Pass stereo	V-Mode 4	404			Configure...
None				Pass stereo	V-Mode 5	405			Configure...
None				Pass stereo	V-Mode 6	406			Configure...
None				Pass stereo	V-Mode 7	407			Configure...
None				Pass stereo	V-Mode 8	408			Configure...
None				Pass stereo	V-Mode 9	409			Configure...
None				Pass stereo	V-Mode 10	410			Configure...
None				Pass stereo	V-Mode 11	411			Configure...
None				Pass stereo	V-Mode 12	412			Configure...
None				Pass stereo	V-Mode 13	413			Configure...
None				Pass stereo	V-Mode 14	414			Configure...
None				Pass stereo	V-Mode 15	415			Configure...
None				Pass stereo	V-Mode 16	416			Configure...

To change the configuration, select the far right “Configure...” button.

Input:

Input (Destination)	
Input selector:	None ▼
Source name:	<input type="text"/>
Address:	<input type="text"/>
Stream type:	L24 2ch (Livewire From source) ▼
Using the "Address" field:	
Blank	Disconnected.
Integer number	Channel number of Livewire multicast stream, range 1 to 32766. Standard RTP port number 5004 will be used.
<Multicast IP>	Address of AES67 multicast stream, range 239.0.0.0 to 239.255.255.255. Standard RTP port number 5004 will be used.
[0.0.0.0]:<port>	Unicast stream receive port number. A stream from any sender will be accepted.
<Unicast IP>:<port>	Unicast stream sender, and the receive port number. Only a stream from the indicated IP address will be accepted.

The **Input selector** is used to select any source native to the Engine or select an “EXTERNAL” source from the network.

Source name is a text field used to document the input.

Address is used to define the Livewire channel number of an “EXTERNAL” source or the address of an AES67 stream.

Stream type is used to define the source. With AES67, the stream could be a linear 24 bit up to 8 channels or linear 16 bit. The Livewire type sources are identified. Make sure you select the correct type.

Mode:

Audio Channel Routing	
Mode:	Pass stereo ▼

Manipulation within the matrix is referred to as routing and will be configured by a mode selection. Two stream classes are utilized within the different mode designations:

- Class “stereo”: streams with 1 or 2 channels (“Left” or “Right” may also be used in this class)
- Class “multi-channel”: streams with 3 to 8 channels

Mode option “Pass multi-channel” passes all 8 matrix inputs to the corresponding outputs transparently.

- Unity gain in all channels
- No up-/down-mixing

- Preserving the channel order regardless of the actual number of channels in the input and output streams
- No signal in output channels, where corresponding channels do not exist at input

Mode option “Pass stereo” passes only the stereo part of the matrix transparently, and blocks the multichannel part.

“Transpose ...” options move two channels between the stereo part of the matrix and channels 1 and 2 of the multi-channel part.

“Upmix ...” and “Downmix ...” options mix, copy, and/or apply gains to input channels, to obtain output channels. Generally, upmixing is a process that creates a bigger channel count at output from a smaller channel count at input (for example, multi-channel from stereo), and downmixing is the opposite (stereo from multi-channel).

“Split ...” options create a mono sum from a stereo input, apply the specified attenuation, and send it to either Left or Right output channel as indicated in the name of the option, while sending no signal to the other.

“Combine ...” options are special in that they take input from two input streams (designated A and B) and output to one stream. The routing is indicated in the name of the option, *Combine A, B*, where the “side” identified with the *A* field results as the *Left* side of the output and *B* field in the *Right* side. For example “Combine Right,Left” takes the stereo *Right side* from the *A stream* input into the *Left side* of the output channel, and Stereo *Left side* from the *B stream* input to the *Right side* of output.

Output:

Output (Source)	
Source name:	<input type="text" value="V-Mode 1"/>
Address:	<input type="text" value="401"/>
Stream type:	<input type="text" value="L24 2ch (Livewire From source)"/>
Packet time (ptime):	<input type="text" value="5ms (Livewire Standard)"/>
Using the "Address" field:	
Integer number	Channel number of Livewire multicast stream, range 1 to 32766. Standard RTP port number 5004 will be used.
<Multicast IP>	Address of AES67 multicast stream, range 239.0.0.0 to 239.255.255.255. Standard RTP port number 5004 will be used.
<Unicast IP>:<port>	Unicast stream destination address and port number.

The output of the matrix will result into a network source. You can define this source to be a Livewire source type or one of the many AES67 options.

Source name is used to identify the source in the network. Livewire sources are advertised and this name is used in the information propagation. AES67 does not define a required method for how sources are advertised. Once this is defined, this name may be utilized.

Address is used to define the Livewire channel number or an AES67 address.

Stream type defines the type of stream to be generated from the matrix output. Similar to the input type field, there are many options available because of AES67 and the type used in Livewire are identified.

Packet time defines the latency and bandwidth consumption of the stream. Livewire has historically given this field a user friendly name such as Live or Standard stereo. The time value is the amount of audio encapsulated within the packet. The shorter time period permits the transmission of audio more frequently with the result of high bandwidth utilization and lower delay at receiver. The longer period results in better packet utilization and thus a lower stream bandwidth with a slower reception at receiver. The ptime used by Livewire devices are identified.

Some VMode examples

Create a Mono Stream From One Side of a Stereo Channel

Sometimes, the program content that is fed on a satellite downlink is received on only the Left channel while another content or information on the Right channel that you don't want to air. Using VMode, you can split the Left and Right sides and create a new source using just the channel you want. Here's how:

Input (Destination)	
Input selector:	EXTERNAL ▼
Source name:	Satellite Rcv
Address:	19201
Stream type:	L24 2ch (Livewire From source) ▼

Audio Channel Routing	
Mode:	Upmix from Left ▼
Click here to see the options explained.	

Output (Source)	
Source name:	V-Mode 1
Address:	401
Stream type:	L24 2ch (Livewire From source) ▼
Packet time (ptime):	5ms (Livewire Standard) ▼

- Select EXTERNAL
- Provide a useful name
- Define the source stream from the network you wish to input. The example assumes Livewire channel 19201.
- Define the type, the example assumes a Livewire stereo source.

- “Upmix from Left” mode
- Define the stream address or Livewire channel number.
- Define the type, again we assume Livewire 2-channel.
- Define the ptime, in the example we define a Livewire Standard Stereo packet.

Create a Split Record Feed from Multiple Sources

You want to create a two channel recording with independent content and gain control for each channel different from Program 1 of the Fusion console. This single stream will be recorded on a stereo recorder. You can construct a custom VMode stream to satisfy this requirement, like so:

V-mode: 1		V-mode: 2	
Input (Destination)		Input (Destination)	
Input selector:	AUX SEND A ▼	Input selector:	AUX SEND B ▼
Source name:	<input type="text"/>	Source name:	<input type="text"/>
Address:	<input type="text"/>	Address:	<input type="text"/>
Stream type:	L24 2ch (Livewire From source) ▼	Stream type:	L24 2ch (Livewire From source) ▼
Using the "Address" field:		Using the "Address" field:	
Blank	Disconnected.	Blank	Disconnected.
Integer number	Channel number of Livewire multicast stream, range 1 to 32766. Standard RTP port number 5004 will be used.	Integer number	Channel number of Livewire multicast stream, range 1 to 32766. Standard RTP port number 5004 will be used.
<Multicast IP>	Address of AES67 multicast stream, range 239.0.0.0 to 239.255.255.255. Standard RTP port number 5004 will be used.	<Multicast IP>	Address of AES67 multicast stream, range 239.0.0.0 to 239.255.255.255. Standard RTP port number 5004 will be used.
[0.0.0.0]:<port>	Unicast stream receive port number. A stream from any sender will be accepted.	[0.0.0.0]:<port>	Unicast stream receive port number. A stream from any sender will be accepted.
<Unicast IP>:<port>	Unicast stream sender, and the receive port number. Only a stream from the indicated IP address will be accepted.	<Unicast IP>:<port>	Unicast stream sender, and the receive port number. Only a stream from the indicated IP address will be accepted.
Audio Channel Routing			
Mode:	Combine Left,Left ▼		
Click here to see the options explained.			
Output (Source)			
Source name:	2-Channel		
Address:	1001		
Stream type:	L24 2ch (Livewire From source) ▼		
Packet time (ptime):	5ms (Livewire Standard) ▼		
Using the "Address" field:			
Integer number	Channel number of Livewire multicast stream, range 1 to 32766. Standard RTP port number 5004 will be used.		
<Multicast IP>	Address of AES67 multicast stream, range 239.0.0.0 to 239.255.255.255. Standard RTP port number 5004 will be used.		
<Unicast IP>:<port>	Unicast stream destination address and port number.		
<input type="button" value="Apply"/>			

The resulting Livewire 2-channel output would have the Left side of AUX A on the Left and Left side of AUX B on the Right.

Create a stereo Livewire stream from a 2-channel AES67 stream.

Input (Destination)	
Input selector:	<input type="text" value="EXTERNAL"/>
Source name:	<input type="text" value="AES67 multicast"/>
Address:	<input type="text" value="239.190.190.190"/>
Stream type:	<input type="text" value="L24 2ch (Livewire From source)"/>

Audio Channel Routing	
Mode:	<input type="text" value="Pass stereo"/>
Click here to see the options explained.	

Output (Source)	
Source name:	<input type="text" value="LivewireFromAES6"/>
Address:	<input type="text" value="1003"/>
Stream type:	<input type="text" value="L24 2ch (Livewire From source)"/>
Packet time (ptime):	<input type="text" value="5ms (Livewire Standard)"/>

What's Next

Telephones are an important part of many stations' on-air programming. Since Axia Audio is a part of Telos, Fusion features tight interoperability with Telos multi-line phone systems. In the next chapter, we'll discuss how to set up your console and phone system to work together seamlessly.

Intentionally Left Blank

Chapter 5

Working With Phones

One of the advantages of a Livewire studio is the smooth integration of Telos telephone interface equipment with the mixing console. Console telephone control modules let operators work phone without taking their eyes or hands off the console; mix-minus is handled automatically, and each fader has its own mix-minus capability, so you will never run out of busses.

Since advanced Telos telephone interfaces have Ethernet connections, they integrate easily with Axia networks, exchanging control signaling between console and phone system without the need for the usual parallel connections.

This Chapter describes how to configure your console for use with Telos talkshow systems. But even if you don't own a Telos phone system, GPIO control of telephone equipment without a Livewire interface is also possible; refer to the GPIO chapter for details.

For details on how to use the Fusion Call Controller module to control multi-line phone systems directly from your console, please refer to the chapter entitled [Operations](#), earlier in this manual.

Phone Setup Choices

There are three methods of setting up phone control with the Fusion console. These methods are referred to as:

- **EU Phone** (networked)
- **US Phone** (networked)
- **No Phone Control** (GPIO enabled control)

EU Phone is the method most used in European countries, wherein a single line is assigned to a single hybrid. This is also known as “hybrid per fader” mode; that is, there is no switching between multiple lines on a single hybrid. Each line is presented on its own dedicated console fader. If four phone lines are desired for use, each line's hybrid is presented on a separate fader. No on-console line controller module is used.

US Phone is the method most common in North America, where the operator has the ability to choose between multiple incoming lines to feed the telephone hybrid. Commonly, two hybrids are presented on separate faders, and the user dynamically switches between incoming lines; the Fusion Phone Controller module is used for this mode of operation.

Most Telos multi-line call systems support both of these two methods.

No Phone Control is a way of controlling third-party hybrids which do not work with Telos control protocols; instead, basic GPIO closures are used to “take” and “drop” lines.

Setting Up for EU Phone Operation

First, create a Source Profile for your fixed hybrid (as described in the section in Chapter 2 of this manual entitled “Working With Profiles”). Then:

1. Select the **Phone Source** type.
2. Select the appropriate **Primary Source** using the adjacent dropdown Source Selector box to pick the desired Livewire channel from your Telos phone system.
3. In the **Phone Control** portion of the Source Profile, there will be an **EU Phone** section as shown in the image below.
 - » Enter the IP Address of the Telos phone system in the **Server IP** box.
 - » Select the Telos phone system you’re interfacing with. Choose from **Telos 2**, **Nx-Series** (shown as *AP (Nx12)*) or **VX** and enter the appropriate settings for the device.
 - If you’re using a Telos TWO, enter the number of the line to be used in the **Line** box.
 - If using an Nx system, enter the Line and Hybrid numbers in their respective boxes. Select the **Use 2nd Show** check box if split shows are enabled on your phone system.
 - If using a VX system, enter the **Studio Name** as configured in your VX Engine, and the number of the **Fixed Hybrid**.

Source Profile:

The screenshot shows the configuration for a 'Phone' source profile. The 'Source type' is set to 'Phone'. The 'Source name' is 'ext-1990'. The 'Source name override' is 'Show sourcename'. The 'Primary source' is '20041 <Fixed@Telos-VX>'. The 'Signal mode' is 'Stereo' and 'Locked' is checked. The 'Signal phase' is 'Normal'. The 'Signal mode for Record bus' is 'Stereo'. The 'Fader trim gain' is '+0.0 dB' and 'Locked' is checked. The 'Panorama position' is '0'. The 'Phone Control' section is expanded, showing 'EU Phone' settings. The 'Server IP' is '192.168.100.200'. The 'Telos 2' option is selected, with 'Line' set to '0'. The 'AP (Nx12)' option is also visible, with 'Use 2nd show (split)' checked, 'Line' set to '0', and 'Hybrid' set to '0'. The 'Vx' option is also visible, with 'Studio name' set to 'Studio 3' and 'Fixed Hybrid' set to '1'.

When finished, remember to save your Source Profile.

Setting Up for US Phone Operation

Using the US Phone method of operation requires the use of the Fusion Call Controller module. With this method, you can use Fusion's Show Profiles feature to instantly recall show setups that choose between different phone systems, or even different phone system configurations.

For example, one Show Profile could call up the configuration needed for a Talk format, while another might recall the configuration needed for music request lines, allowing a single studio to be the Control Room for any station in a cluster.

Using this mode requires two steps: defining a **Show Profile**, then defining **Source Profiles**.

Show Profile Settings For US Phone Operation

First, create a new Show Profile using the instructions found in the "Show Profiles" section of Chapter 2 of this manual.

Then, configure your new show profile. The Show Profile page of your Fusion's Web interface displays the name of the show, all the Channels (faders) of the surface, followed by several additional items, one of which is the **Phone** link. If more than one Call Controller module is installed in your console, multiple instances of this configuration option will be shown.

Select the **Phone** link to display the following screen:

Show profile 'OnAir'. Phone configuration:

Phone Module 1

Phone Type: AP (Nx12)
 Vx

Phone Server IP:
format: [user[:pass]@]host

Show Name:

Host / Studio Name:

Show Password:

Reversed Hybrid (1st on right)

Mode: Auto

The **Phone Type** is where you select the protocol used to communicate with the call server. Prior to the VX system, the AP protocol was used. The AP option is to support legacy Telos products still in use, otherwise you would likely select the VX option.

The **Phone Server IP** is where you identify the IP address of the Telos product that is managing the calls. In cases where the non-default user name or password is to be used, you would add those in the text box. An example is MyUser:MyPass@192.168.2.66 .

The **Show Name field** is used to identify a phone system configuration when using a Telos Series 2101 or VX system. These names are defined in your phone system’s setup. Enter the configuration name you wish your Call Controller to log into.

Note: with the VX system, this field can be left blank, permitting the changing of the show assigned with a VSet phone, or the VX interface.

The **Host / Studio Name field** is used differently with different systems.

- With **VX systems**, use this field to define the “Studio” name. This information allows the Fusion Call Controller to interface with the appropriate configuration as defined in the VX. An incorrect name instructs the Fusion to connect to a non-existing configuration, which is indicated by a circling icon on the top left of the Call Controller.
- In legacy Telos phone systems, this field is used to log into the appropriate configuration:
 - » “Hybrid1”, “Hybrid2”, “Hybrid1&2” (used in **TWO-x-12**)
 - » “Hybrid 1&2”, “Hybrid 3&4”, “Hybrid 1-4” (used in **Nx6 & Nx12**)

The **Show Password** field is used to permit access between your Fusion console and any Telos Call system that has password protection at show levels. If you have a password for the phone system Show you want to use, enter it here.

The **Reversed Hybrid** option swaps the banks of the Call Controller. By default, the left column controls Hybrid 1, and the right column controls Hybrid 2; selecting this option reverses these.

The **Mode** option defines the operation of the two Call Controller columns for line selection. The default is **12 lines**, which provides control for Hybrid 1 and Hybrid 2. The **24 lines** option is available for high call requirements and, when setting each button as a different line.

Once you’ve entered the information required for your phone system, save your changes and proceed to Source Profile configuration.

Source Profile Settings for US Phone Operation – VX & Nx Systems

You’ll need to create a Source Profile for your fixed hybrid (as described in the section in Chapter 2 of this manual entitled “Working With Profiles”). In legacy Telos Phone systems, you may have 1, 2, or even 4 hybrids; with VX systems, the number may be many more.

To begin:

1. Select the **Phone Source** type.
2. Select the appropriate **Primary Source** using the adjacent dropdown Source Selector box to pick the desired Livewire channel from your Telos phone system.
3. In the **Phone Control** portion of the Source Profile, you’ll skip the EU Phone section and move to the **US Phone** section. This will only appear if a Call Controller module is installed, as shown in the image below.

- » Enter the IP Address of the Telos phone system in the **Server IP** box.
- » Select the Telos phone system you're interfacing with. Choose from **Telos 2**, **Nx-Series** (shown as *AP (Nx12)*) or **VX** and enter the appropriate settings for the device.
 - If you're using a Telos TWO, enter the number of the line to be used in the **Line** box.
 - If using an Nx system, enter the Line and Hybrid numbers in their respective boxes. Select the **Use 2nd Show** check box if split shows are enabled on your phone system.
 - If using a VX system, enter the **Studio Name** as configured in your VX Engine, and the number of the **Fixed Hybrid**.
- » Select the **Call Controller 1** radio button (if you have multiple Call Controllers installed, select the appropriate one).
- » In the **Hybrid** box, enter the hybrid number you want this Source Profile to be associated with.
- » The **Fixed Line** box is another method to do what the EU Phone method accomplishes; i.e., assigning a dedicated line to a dedicated fader. Most users with Call Controllers will not use this option.
- » The **Mashing Allowed** checkbox permits a single hybrid to handle multiple callers at once by allowing the board operator to select multiple line buttons. Check (or un-check) this box as you desire.

Source Profile:

Source type: Phone

Source name: NX H2

Source name override: Show sourcename

Primary source: 20063 <S8:Selectable 3@Telos-NX>

Signal mode: Stereo Locked

Signal phase: Normal

Signal mode for Record bus: Stereo

Fader trim gain (-25 .. 25 dB): +0.0 dB Locked

Panorama position (-24 .. 24): 0

Phone Control:

No Phone Control

EU Phone:

Server IP:

Telos 2: Line:

AP (Nx12): Use 2nd show (split)
Line:
Hybrid:

Vx: Studio name:
Fixed Hybrid:

US Phone:

Call Controller 1

Hybrid:

Fixed Line:

Mashing allowed

Source Profile Settings for US Phone Operation – Hx6 & iQ6 Systems

As with the other systems discussed here, you'll begin by creating a Source Profile for each of your Hx6 or iQ6 hybrids.

Source Profile:

Source type: Phone

Source name: iQ6 -1

Source name override: Show sourcename

Primary source: 10601 <Hybrid1@iQ6>

Signal mode: Stereo Locked

Signal phase: Normal

Signal mode for Record bus: Stereo

Fader trim gain (-25 .. 25 dB): +0.0 dB Locked

Panorama position (-24 .. 24): 0

Phone Control:

No Phone Control

EU Phone:

Server IP:

Telos 2: Line:

AP (Nx12): Use 2nd show (split)

Line:

Hybrid:

Vx: Studio name:

Fixed Hybrid:

US Phone:

Call Controller 1

Hybrid:

Fixed Line:

Mashing allowed

1. Select the **Phone Source** type.
2. Select the appropriate **Primary Source** using the adjacent dropdown Source Selector box to pick the desired Livewire channel from your Telos phone system.
3. In the **Phone Control** portion of the Source Profile, you'll skip the EU Phone section and move to the **US Phone** section.
 - » Select the **Call Controller 1** radio button, then and enter the hybrid number in the **Hybrid** box. The iQ6 and Hx6 have two hybrids, so the option will be either 1 or 2.
 - » Leave the **Fixed Line** entry at 0.

Repeat these steps to create a Source Profile for your phone system's second hybrid.

The Show Profile itself also needs configuration, to allow the console to log into the Telos Phone system as a client. To do this, click on the desired Show Profile in your Fusion's Web UI, and select the **Phone** link.

Show profile 'iQ6 Connect'. Phone configuration:

Phone Module 1

Phone Url {vx:|ap:|}[user[:pass]@]host

Show Name:

Host / Studio Name:

Show Password:

Reversed Hybrid (1st on right)

Mode: Auto
 12 Lines
 24 Lines

- Enter the server information in the **Phone URL** field, so:
vx:username:password@xxx.xxx.xxx.xxx
 where *xxx.xxx.xxx.xxx* is the IP address of your phone system. (Hx6 and iQ6 systems use Telos VX control protocol, so the **vx** prefix in this example is correct.)

A shortcut in Fusion assumes default values. If default values are used in your phone system, it would be possible to enter

vx:xxx.xxx.xxx.xxx

*in this field, without explicitly entering the username and password. Check your Telos product to verify username and password. Default settings of the iQ6/Hx6 is a username of **user** with no password.*

- In the **Host/Studio Name** box, enter the value of Hybrid 1&2.

Save your changes and load the Show Profile to your console. The Call Controller will show a dot in the first 6 line selections if the lines are present. If the first line selector is showing a spinning square, there is difficulty logging into the Phone system. Check your settings and verify the Telos phone system is online.

Operating Options

When selecting a line directly using the Call Controller module, the default behavior is for the Left column of buttons to assign the line to Hybrid 1, and the Right column to assign the line to Hybrid 2. But when using phone systems with more than two hybrids, you may assign lines to hybrids other than the default by using the appropriate Source Profile options.

For instance, in the example illustrated in the screen capture above, the third Hybrid in an Nx system is configured for use with a console that has a single call controller installed. This Source Profile would be assigned to any of the standard fader strips on the console (not to the fader associated with the Call Controller).

To select a line to use with this #3 hybrid, the board operator would press the **A** key on the fader strip. The words **Take Line** will then appear on the channel display; the operator can then select any line from the Call Controller and it will be assigned to this hybrid for use.

(New in version 3.2) The Call Controller module has a transfer button which may work depending on the phone system which the module behaves as a client to. The operation if transfer is supported is as follows:
 press xfer key ==> number pad appears on screen, user can enter a number
 pressing # would transfer first ON_AIR line

---OR---

pressing line button would transfer selected line if it is ON_AIR

Setting up for GPIO control (“No Phone Control”)

The **No Phone Control** option is the default selection when you create a new Phone Source Profile. This type is intended for single line hybrids like the Telos Hx1 and Hx2, but can also be used with older single-line Telos phone systems as well as those made by other phone system vendors.

Please refer to the GPIO Telephone Hybrid Logic chart found in Appendix B of this manual for the appropriate pinouts.

When configuring a Source Profile for this operational mode, the salient field is the **Hybrid Answer Mode** dropdown box.

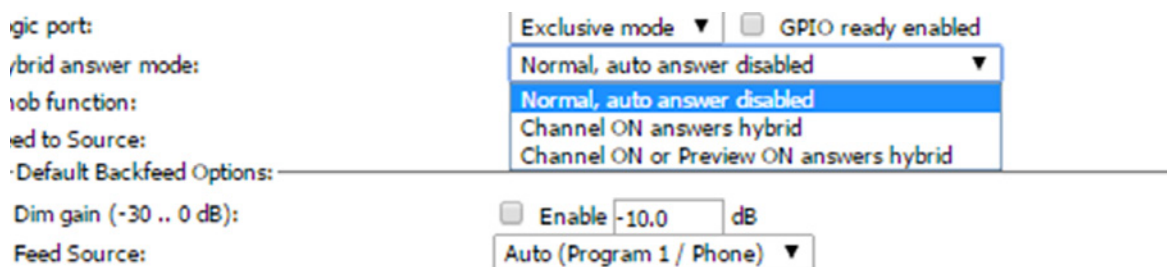

The default setting for Hybrid Answer mode is **Normal, Auto Answer Disabled**. If your desire is to achieve pulses on pins 4 and 5 of the GPIO logic port associated with your phone hybrid, then you must choose one of the two other options. These other options will create pulses when the channel changes ON state or Preview state.

Wiring from a GPIO port that has been configured with this channel to the hybrid is the next step. Again, refer to Appendix B for the appropriate pinout charts, but here’s a quick reference chart:

Telos Hx1 DE-9 Pin	Axia GPIO port DA-15 P
Pin-1	Pin-7
Pin-2	Pin-4
Pin-3	Pin-5

Additional Phone Type Source Profile Options

There are a few more phone-specific options that are available in Phone source profiles. Here's an overview:

Hybrid answer mode:

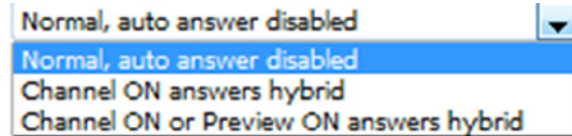

- **Hybrid Answer Mode.** Your choices are:
 - » **Normal, Auto Answer Disabled.** This is the default; turning on the fader that the hybrid is assigned to does not pick up the selected line.
 - » **Channel ON Answers Hybrid.** Turning the fader on immediately picks up the selected line.
 - » **Channel ON or Preview ON Answers Hybrid.** As above. Additionally, placing the fader channel in **Preview** answers the call; the board operator can then talk to the caller through the Operator Mic.

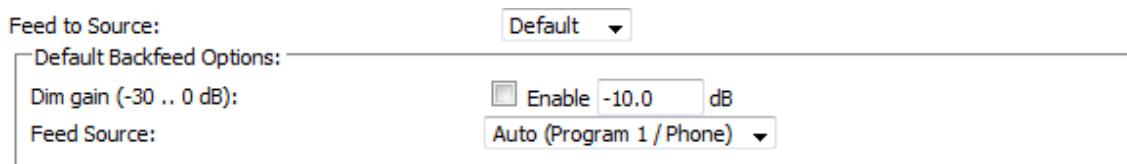

- **Feed To Source:** This setting controls the mix-minus that's automatically generated and fed back to the phone caller.
 - » **Disabled** means no mix-minus will be generated for the caller, so they will not hear you talking to them!
 - » **Default** (the option most often chosen) enables mix-minus for the caller, and enables a couple of additional options:
 - **Dim Gain** lets you trim the volume of the generated backfeed.
 - **Feed Source** defaults to **Auto**, which automatically generates a backfeed constructed of PGM-1 *minus* caller audio when the fader is On, and feeds the offline **Phone** mix to the caller when the fader is Off. This is the most commonly used mode, but you may also specify any of the other Program or Aux Send buses.
 - » **Custom** enables a power-user's toolkit of mix-minus options to build custom backfeeds with selectable GPIO Monitor and Program Bus assignments based on channel On/Off/Preview state. (We'll cover details of these settings in the Advanced Configuration section of this manual.)

When you are done entering configurations, be sure to save your Show and Source profiles, and then load your Show Profile and newly created Phone sources to your console.

Intentionally Left Blank

Appendix A

Advanced Configuration Reference

This appendix lists the advanced options available when setting up Show Profiles, and the “magic key” combinations available from the console surface.

Part 1 – Magic Key Sequences

The key sequences below will allow you access information about your Element using the main display screen. These keys are located on your Monitor Module.

- **IP Address Book** — * + 4 + 7 (hold for 5 seconds): View and change console IP, Gateway and NTP Server addresses, and set surface Web page password.
- **Timer Options key** (hold for 5 seconds): A momentary press invokes board-op timer start/stop functions, but when held for 5 seconds, Engineer can reset time of day, enable/disable NTP sync, set time zone, and choose 12-hour or 24-hour clock format.
- **Capture Mode** — * + 2 (hold for 5 seconds): Invokes “Capture” mode. Use this when adding or removing modules to capture new console configuration.
- **Test Mode** — * + # + 2 (hold for 5 seconds): Invokes “Test” mode to test functions of installed modules.
- **Module Information** — # + * (hold for 5 seconds): Displays information about installed modules.
- **VOCO8 Control** — * + 4 + 8 (hold for 5 seconds): Displays the VOCO8/Sound 4 control interface.
- **Show Profile Reset:** Press and hold the Show Profile key for 5 seconds to discard any changes made to the last-loaded Show Profile. This resets the console to the baseline values of the last-loaded Show Profile.

With Expert Monitor Module only, pressing and holding ? for 5 seconds displays a list of the “magic key” menus available.

Part 2 – Show Profiles Options

Show Profiles are snapshots that allow you to set up a console the way your talent wants it, then save and recall those settings with one button press. Up to 99 Show Profiles can be saved per console.

The easiest way to create a Show Profile is to set up your console the way you like it using the controls on the board itself – then use the **Capture Show Profile** link found on the **Shows** screen of your Fusion control center web page. This will take a snapshot of the entire console – fader assignments, source EQ, mic dynamics, Monitor assignments, even headphone EQ settings – and save them to a new Show Profile that you can use as-is, or edit later. When capturing, the settings will be part of the show profile. Many of the options have a retain option which will not be captured. The retain option permits an existing setting to carry over in the new Show Profile. For example, if a source is loaded which has a *Signal mode* of LEFT, the capture process will apply the LEFT setting as part of the Show Profile. If the Show profile is later edited, so that a different source is loaded, the LEFT option would still be in place unless altered. In some cases the retain is advised.

There are also some options, such as Record Mode setup, that are *not* able to be set from the Fusion surface itself, and must be set up by editing the Show Profile itself. In the next few sections, we'll give you a line-item reference listing of the options found on each Show Profile screen.

Channel Screen Options

There's a Channel Screen for each of your installed faders and virtual faders that are enabled. Following is a listing of options presented on each screen.

NOTE: choosing The "Retain Source Setting" option for any item leaves that item unchanged when loading the Show Profile.

General Controls Section

Source ID

- Dropdown box selects fader's assigned source from saved Source Profiles.

Feed To Source Mode

If the loaded source has a mix-minus, chooses the source for mix-minus creation.

- **Auto** lets the console choose a mix-minus source automatically.
- **Phone**, **PROGRAM** and **AUX SEND** options let you manually choose the bus to use as the basis of the mix-minus.

Auto-Start Timer

- **Enable:** Console interval timer starts when fader ON key is pressed.
- **Disable:** Timer is unaffected by fader ON key.

Signal Mode

- **Stereo:** sets source signal mode to Stereo.
- **Left / Right:** takes the chosen side of the input signal and sends it to both sides of the stereo channel.
- **Sum:** Creates a sum of both input channels and sends the sum to both sides of the stereo channel.

Signal Mode Locked

- **Unlocked:** allows board op to change the Signal Mode from the surface.
- **Locked:** prevents board op from making changes.

Fader Trim Gain

- Select the Use: radio button to specify a fader trim cut or boost between -25 and +25 dB.

Fader Trim Lock

- **Unlocked:** allows board op to trim the fader using Channel controls on the console.
- **Locked:** prevents board op from making changes.

Panorama Position

- Select the Use: radio button to Pan the input signal left or right of center.

Phase

- **Normal:** No phase change to input signal.
- **Invert Left:** Reverses the phase of the left input channel only.
- **Invert Right:** Reverses the phase of the right input channel only.
- **Invert Left and Right:** Reverses the phase of both input channels.

EQ Active

- **Bypass:** Loads the input source with no EQ adjustment.
- **Active:** Loads the source with EQ active, and applies EQ settings specified in following sections.

EQ High Mode

- **Shelf:** Selects high-shelf style of EQ application.
- **Peak:** EQ is applied to a selected frequency, “notch filter” style.

EQ High/Mid/Low Frequency

- Select the **Use:** radio button to set the center frequency of the selected band.

EQ High/Mid/Low Gain

- Select the **Use:** radio button to specify an EQ cut or boost between -25 and +15 dB to the selected frequency.

Assign To...

- **On:** Assigns fader strip to the specified Program or Aux Send bus upon Show Profile load.
- **Off:** Removes fader strip from the specified Program or Aux Send bus upon Show Profile load.

NOTE: Channels may be simultaneously assigned to any combination of Program 1 – 4 and Aux Send 1 – 4 mixing buses.

Aux Send A-B-C-D Pre/Post Fader

- **Pre-Fader:** Sends the input source to the selected Aux Send bus *before* fader gain adjustment.
- **Post-Fader:** Sends the input source to the selected Aux Send bus *after* fader gain adjustment.

Aux Send A-B-C-D Pre/Post ON

- **Pre-ON:** Sends the input source to the selected Aux Send bus *before* the channel’s ON/OFF switch.
- **Post-ON:** Sends the input source to the selected Aux Send bus *after* the channel’s ON/OFF switch.

Aux Send A-B-C-D Gain

- Select the **Use:** radio button to specify any additional gain or cut to be applied to the assigned source before sending to the selected Aux Send bus.

Noise Gate Status

- **Bypass:** Turns off the noise gate feeding the Vocal Compressor section.
- **Active:** Turns on the Compressor noise gate.

De-Esser Status

- **Bypass:** Turns off the Compressor De-Essing function.
- **Active:** Turns on De-Essing function.

Noise Gate Threshold

- Select the **Use:** radio button to specify the level, up to -50 dB, at which the Noise Gate activates to attenuate input signals that fall below that level.

Noise Gate Depth

- Select the **Use:** radio button to specify the amount, up to -30 dB, of attenuation to apply to the input signal when the specified Threshold is met.

Compressor Threshold

- Select the **Use:** radio button to specify the ceiling, up to -30 dB, at which the Compressor activates to attenuate input signals above that level.

Compressor Ratio

- Select the **Use:** radio button to specify the aggressiveness of the compressor, up to 16:1.

De-Esser Threshold

- Select the **Use:** radio button to specify the ceiling, up to -20 dB, at which the De-Esser activates to attenuate sibilance.

De-Esser Ratio

- Select the **Use:** radio button to specify the aggressiveness of the De-Esser, up to 8:1.

Compressor Mode

- **No Freeze:** The compressor is “free” to operate no matter the input level.
- **Freeze:** Prevents the compressor from “sucking up” room noise during brief pauses in audio input.

Backward Feed Dim Gain

- Select the **Use:** radio button to specify the amount of attenuation, up to -30 dB, will be applied to program audio being fed back to this source (if it has an associated Backfeed, such as an IFB or Talkback channel).

Channel On/Off Status

- **Safe ON:** If the fader is ON, and the Show Profile specifies a new source be loaded to this fader, the new source will be queued until the fader is turned off.
If the new source is the same as the old source, the fader is immediately turned ON when the Show Profile loads.
- **Force OFF:** Immediately turns the fader OFF when the Show Profile loads.
- **Force ON:** Immediately turns the fader ON when the Show Profile loads. If a new source is to be loaded to the fader, it is changed immediately, regardless of whether audio from a previous source is passing through the fader.

Control Lock Map

- **PGM1 – PGM4, Options, Preview, On/Off, Fader, Talkback, HP Source:** Place a check mark in any of these boxes to keep the board up from changing the Show Profile's pre-selected options for this fader.

Group Start

Fusion contains a Group Start feature that enables the user to turn several faders ON by pressing the ON key of the Master fader; useful in roundtable discussions or multi-talent bullpens.

This function can be controlled in this screen, or by setting the option in each individual Channel Options screen.

- **Master:** Designates this fader channel as a Group Start Master. Pressing its ON or OFF keys will turn Slave faders on and off as well.
- **Slave:** Designates this fader channel as a Slave. It will mirror the ON/OFF state of the Group Start Master fader.
- **Independent:** Normal ON/OFF operation.

Fader Position

- Select the **Use:** radio button to specify the level at which the fader should be set when the Show Profile is loaded. You may specify any level between -73 dB and +10 dB.

This setting operates in conjunction with the **Channel On/Off Status** described above. Using these two settings, you can set a channel to turn ON, and its fader to assume a preset output value, when the Show Profile is loaded. This is useful when creating a Show Profile for use with automation systems; combine it with the **Control Lock Map** controls to set up a Show Profile for unattended, automated operation with controls that cannot be inadvertently changed by careless operators.

Individual Headphones Section

Any Fusion input defined as a Microphone source can have a dedicated headphone feed, to facilitate individual Talkback (IFB) to and from the board operator or other talent. The options below affect this dedicated headphone feed, if enabled.

Current Source

- If a Microphone source is loaded to this channel, choose the audio source to be fed to its Individual Headphone Feed (Backfeed), if desired. Choices include all Program and Aux Send buses, Monitor bus, or a direct feed from any individual source.

Source For Preset 1 / Preset 2

- Select the audio source assigned to the Preset keys on Axia Talent Headphone accessory panels. Choices include all Program and Aux Send buses, Monitor bus, or a direct feed from any individual source.

Headphones Master Gain

- Select the **Use:** radio button to specify the level at which Individual Headphone channel should be fed. You may specify any level between -85 dB and 0 dB.

Talkback Start Volume Low Limit

- Select the **Use:** radio button to specify the level at which Talkback will be fed to the Individual Headphone channel. You may specify any level between -85 dB and 0 dB.

Record Mode Section

Fusion's Record Mode is a "macro" that allows complex pre-defined operations to take place with a single button press. The options below define bus assignments for the channel that occur when Record Mode is entered and exited.

Program 1 – 4

- **Assign, While In Record Mode:** Assigns this channel to the selected Program bus when Record Mode is active.
- **Remove, While In Record Mode:** Removes this channel from the selected Program bus until Record Mode is exited.
- **No Change, While In Record Mode:** This channel's bus assignments do not change when Record Mode is active.

ON/OFF

- **Disable, While In Record Mode:** Prevents the operator from changing the channel ON/OFF state when Record Mode is active.
- **No Change, While In Record Mode:** Channel ON and OFF keys function normally during Record Mode.

When done editing the Channel options, be sure to click the **Save Changes** button. You'll be returned to the Show Profile options screen.

Auxiliary Send & Return Screen Options

This screen allows you to pre-select settings pertaining to the 4 Aux Send and 2 Aux Return mixing buses.

Aux Send A-B-C-D Master Gain

- Select the **Use:** radio button to specify the master gain level at which the selected Aux Send bus will be set. This is the gain applied to the Aux Send bus after any sources have been assigned to it. You may specify any level between -60 dB and +10 dB.

Aux Send A-B-C-D On/Off Status

- **Off:** Turns off selected Aux Send bus upon Show Profile load.
- **On:** Turns on selected Aux Send bus upon Show Profile load.

Aux Return A-B Gain

- Select the **Use:** radio button to specify the gain level at which the selected Aux Return bus will be set. You may specify any level between -60 dB and +10 dB.

Aux Return A-B On/Off Status

- **Off:** Turns off selected Aux Return bus upon Show Profile load.
- **On:** Turns on selected Aux Return bus upon Show Profile load.

Aux Return A-B Signal Mode

- **Stereo:** sets bus signal mode to Stereo.
- **Left / Right:** takes the chosen side of the bus' stereo signal and sends it to both sides of the stereo bus output channel.
- **Sum:** Creates a sum of both stereo channels and sends the sum to both sides of the stereo bus output channel.

Aux Return A-B Panorama Position

- Select the **Use:** radio button to Pan the output signal of the bus to left or right of center.

Aux Return A-B Assign To PGM1-2-3-4

- **On:** Assigns the output of the specified Aux Return bus to the selected Program bus(es) upon Show Profile load.
- **Off:** Removes the output of the specified Aux Return bus to the selected Program bus(es) upon Show Profile load.

Aux Return A-B Source ID

- Dropdown box selects Aux Return's assigned source from saved Source Profiles. Note that Program and other Aux buses are not available in this dropdown; choices are limited to external devices only.

When done editing the Aux Send & Return options, be sure to click the **Save Changes** button. You'll be returned to the Show Profile options screen.

Monitor Section Screen Options

Options in this section permit you to define Control Room and Studio Monitors & Headphone selections, and determine how on-screen Meters and Timers will behave when this Show Profile is loaded.

General Monitor Settings Section

Timer Mode (Onscreen "Count-Up" Timer)

- **Manual:** Gives board operator manual control of the event timer using the Timer keys found on the console's Monitor Module.

NOTE: This setting interoperates with the Auto-Start Timer option. The Auto-Start Timer option can be set in two ways:

- Check the Auto-Start Timer box in a Source Profile to enable the function whenever a source is loaded to any fader.
 - Use the Auto-Start Timer selection found in the Show Profiles Channel Options screen to override the Source Profile setting for a particular Show.
-

- **Auto-Reset:** Timer resets to zero and begins counting when a fader is turned ON.
- **Auto-Add:** Timer begins counting when a fader is turned ON and stops counting when that fader is turned OFF. In this mode, the timer will not reset to zero when it is restarted.

Show Tenths On

- **No Timers:** Tenths-of-a-second are hidden on both Count Up and Countdown timers.
- **Down Timer:** Tenths are only shown on the Countdown timer.
- **Up Timer:** Tenths are only shown on the Count Up timer.
- **Both Timers:** Tenths are shown on both timers.

Preview Interlock Mode

- **Disabled:** Board op can “button mash” multiple Preview buttons to preview multiple sources.
- **Enabled:** Button-mashing is disabled; selecting a Preview button removes any other source from the Preview bus.

Switched Meter Source Select

- **Program-4:** Selects Program 4 mixing bus to be metered on the #4 on-screen meter display.
- **CR Monitor/Preview:** Switches the #4 meter to the Control Room Monitor channel. When a source is placed in Preview, meter switches to display loudness of the source in Preview.

Program 3 Meter Input

- Dropdown box allows you to select from **Program 3**, **Record bus**, **Phone bus** or the sources assigned to the Monitor Module’s **External 1** and **External 2** choices to be displayed on the #3 meter.

Preview Speaker Master Gain

- Select the **Use:** radio button to specify the level at which the Preview bus will be set when the Show Profile is loaded. You may specify any level between -85 dB and 0 dB.

Preview Speaker Muted State Gain

- Select the **Use:** radio button to specify the level at which the Preview bus will be heard when it is muted. You may specify any level between -85 dB and 0 dB.

NOTE: Normally, turning a Control Room microphone channel ON mutes the Preview speakers entirely. This setting allows you to let the Preview bus be heard in the Control Room at a reduced level, even while CR Mics are active.

Source ID For External Preview

- Dropdown box allows any Source not assigned to a fader to be heard in the Preview channel. Note that this must be enabled by a pin on the CR Monitor GPIO.

Example: you have an intercom system you wish to feed into the console's Preview channel. To do this, use the Dropdown box to select the intercom's audio source, then take the GPO from the intercom and use it to gate open the External Preview input, which would be fed by the intercom audio.

Talkback Gain

- Select the **Use:** radio button to trim the level of the Talkback channel. You may specify any level of cut or boost between -30 dB and +10 dB.

Feed To Source Sum Gain

- Select the **Use:** radio button to specify a gain compensation for mono-sum of Talkback audio sources. You may specify between -6 dB and -3 dB of attenuation.

User Buttons GPIO Channel

- If you have a Fusion Expert Monitor Module and wish to control an external device using its 4 User keys, enter the GPIO Channel Number of the device here.

GPIO Channel For Up Timer Control

- Allows an external device to trigger the Up Timer. Enter the GPIO Channel Number for the desired device.

GPIO Channel For Down Timer Control

- Allows an external device to trigger the Down Timer. Enter the GPIO Channel Number for the desired device.

Additional Meters Section

Extra Meter 1-2-3-4 Input

- This section allows to you specify meter sources for the “extra” meters that can be displayed in the center section of Fusion's on-screen display when using an Expert Monitor Module. The selections for each of the meters are extensive and include all **Program, Aux, External** and **Monitor** busses, the **Phone** and **Record** buses, all **Fader Channel sources and backfeeds**, all **VMix inputs, Direct, Sub** and **Main** outputs, as well as all **VMode inputs and outputs**.
- The extra meters are displayed when the board operator presses the **Meter Options** key and presses the #6 Function knob to select the **More Meters** option.

Sources For External 1 & 2 Section

Source ID For External Input 1 – 2

- Use the Dropdown boxes to select sources to be loaded to the **External 1** and **External 2** Monitor Selection keys when the Show Profile is loaded.
- Board operators can override these selections by pressing and holding the External keys for 5 seconds, then choosing from the onscreen list of sources.

Control Room Monitor Options Section

Source

- Use the radio buttons to choose the source that will be selected to feed the Control Room Monitor speakers upon Show Profile load.

CR Monitor Master Gain

- Select the **Use:** radio button to specify the level of the CR Monitor speakers upon Show Profile load. You may specify a value between -85 dB and 0 dB.

Signal Mode: CR Monitor

- **Stereo:** sets Monitor channel to Stereo.
- **Left / Right:** takes the chosen side of the Monitor channel and sends it to both speakers.
- **Sum:** Creates a sum of both sides of the Monitor channel and sends the sum to both speakers.

CR Monitor Dim Gain

- Select the **Use:** radio button to specify the amount of attenuation, up to -30 dB, to be applied to the CR Monitor channel when Talkback or Preview are in use.

CR Monitor Muted State Gain

- Select the **Use:** radio button to specify the amount of attenuation, up to -85 dB, to be applied to the CR Monitor channel when muted.

NOTE: Normally, turning a Control Room microphone channel ON mutes the CR Monitor speakers entirely. This setting allows you to let the monitors to be heard in the Control Room at a reduced level, even while CR Mics are active.

GPIO Channel For CR Monitor

- Enter the GPIO channel number used to trigger On Air lamps or other GPIO functions. This option should typically be programmed with the same logic channel number for all Show Profiles.

Control Room Headphones Options Section

Source

- Use the radio buttons to choose the source that will be selected to feed the Control Room headphones upon Show Profile load.

CR Headphones Master Gain

- Select the **Use:** radio button to specify the level of the CR Headphones upon Show Profile load. You may specify a value between -85 dB and 0 dB.

Signal Mode: CR Headphones

- **Stereo:** sets Headphone channel to Stereo.
- **Left / Right:** takes the chosen side of the Headphone channel and sends it to both speakers.
- **Sum:** Creates a sum of both sides of the Headphone channel and sends the sum to both speakers.

CR Headphones Independent

- **Follow Monitors:** CR Headphone source mirrors CR Monitor source selection.
- **Use Headphones Source Select:** CR Headphones and CR Monitors are selected independently.

Preview-In-Headphones Mode

- **Off:** Sources assigned to Preview bus are not heard in CR Headphones.
- **Stereo:** Sources assigned to Preview bus are heard in both sides of the CR Headphones.
- **Split:** Sources assigned to Preview bus are summed to mono and heard only in right side of the CR Headphones. Regular audio is heard in left side.

CR Headphones EQ Active

- **Bypass:** No headphone EQ.
- **Active:** Headphones are EQd using the following settings.

CR Headphones EQ High Mode

- **Shelf:** Selects high-shelf style of EQ application.
- **Peak:** EQ is applied to a selected frequency, “notch filter” style.

CR Headphones EQ High/Mid/Low Frequency

- Select the **Use:** radio button to set the center frequency of the selected band.

CR Headphones EQ High/Mid/Low Gain

- Select the **Use:** radio button to specify an EQ cut or boost between -25 and +15 dB to the selected frequency.

Studio Monitor Options Section

Source

- Use the radio buttons to choose the source that will be selected to feed the Studio Monitor speakers upon Show Profile load.

Source ID For External Input

- Dropdown box chooses what source will be auditioned when External is chosen from the Studio monitor assignment list.

Studio Monitor Master Gain

- Select the **Use:** radio button to specify the level of the Studio Monitor speakers upon Show Profile load. You may specify a value between -85 dB and 0 dB.

Studio Monitor Dim Gain

- Select the **Use:** radio button to specify the amount of attenuation, up to -30 dB, to be applied to the Studio Monitor channel when Talkback or Preview are in use.

Studio Monitor Muted State Gain

- Select the **Use:** radio button to specify the amount of attenuation, up to -85 dB, to be applied to the Studio Monitor channel when muted.

NOTE: Normally, turning a Studio microphone channel ON mutes the Studio Monitor speakers entirely. This setting allows you to let the monitors to be heard in the Studio at a reduced level, even while Studio Mics are active.

GPIO Channel For Studio Monitor

- Enter the GPIO channel number used to trigger On Air lamps or other GPIO functions. This option should typically be programmed with the same logic channel number for all Show Profiles.

Master Module Control Lock Map Section

- This functions like a “master lock” for console functions – a superset of the Control Lock Map found in the Show Profiles Channel Options pages. You can essentially prevent any setting on the board from being changed if you so desire.

Place a check mark in any of these boxes to keep the board op from changing the Show Profile’s pre-selected options.

When done editing the Monitor Section options, be sure to click the **Save Changes** button. You’ll be returned to the Show Profile options screen.

Record Mode Screen Options

Record Mode is like a “macro” that helps talent quickly prepare to record phone bits, interviews or other program segments for later airing. Any source assigned to the Program-4 bus automatically feeds the Record and Phone buses as well.

Sources assigned to Program-4/Record will follow the Record options in their Source Profiles; the options here primarily affect the behavior of Monitors when Record Mode is invoked.

Record Mode Configuration Section

Record Mode Activation

- **Disabled:** Disables Record Mode entirely for this Show Profile.
- **Enabled:** Allows activation of basic Record Mode for this Show Profile. CR Monitor and CR Headphone assignments automatically switch to the Program 4 bus, and the bus assignment keys for channels assigned to Program 4 flash.
- **Flexible:** Allows activation of Flexible Record Mode, with custom Monitor, Headphone and Meter options set in the “Flexible Record Mode Options” section that follows.

GPIO Channel For Recorder Control

- Enter the GPIO channel number used to trigger your dedicated recording device. This option should typically be programmed with the same logic channel number for all Show Profiles.

Flexible Record Mode Options Section

When “Flexible” is chosen as the Record Mode Activation option, the following options are active.

NOTE: The options below allow you to customize the Monitor, Headphone and Meter settings that are automatically selected when you *ENTER* Record Mode.

CR Monitor Source

- **Retain:** Does not change the Monitor feed; keeps the Monitor selection the board operator was using prior to entering Record Mode.
- **Program 1 – 4, Record, Phone, Auxiliary A – D, External 1 – 2:** Changes the Monitor feed to the selected bus or Monitor channel when Record Mode is engaged.
- **Recall:** Re-loads the Monitor selection that was manually selected by the board operator *the last time* Record Mode was active.

Studio Monitor Source

- Same options as described in “CR Monitor Source” above, but for the Studio Monitor feed.

CR Headphone Source

- Same options as described in “CR Monitor Source” above, but for the Control Room Headphone feed.

4th Meter Source

- **Retain:** Does not change the #4 Meter on the Fusion display; keeps the Meter selection the board operator was using prior to entering Record Mode.
- **Program 4, Record, Phone, Auxiliary A – D, External 1 – 3, Monitor:** Changes the #4 Meter to the selected bus, external source, or the audio of the CR Monitor when Record Mode is engaged.
- **Recall:** Re-loads the #4 Meter selection that was manually selected by the board operator *the last time* Record Mode was active.

When done editing the Record Mode options, be sure to click the **Save Changes** button. You’ll be returned to the Show Profile options screen.

Group Start Screen Options

Group Start

Fusion contains a Group Start feature that enables the user to turn several faders ON by pressing the ON key of the Master fader; useful in roundtable discussions or multi-talent bullpens.

This function can be controlled in this screen, or by setting the option in each individual Channel Options screen.

- **Master:** Designates this fader channel as a Group Start Master. Pressing its ON or OFF keys will turn Slave faders on and off as well.
- **Slave:** Designates this fader channel as a Slave. It will mirror the ON/OFF state of the Group Start Master fader.
- **Independent:** Normal ON/OFF operation.

When done editing the Group Start options, be sure to click the **Save Changes** button. You'll be returned to the Show Profile options screen.

Automix Screen Options

Automix

Fusion has an automix feature that allows for smart mixing of designated channels to control group conversations or provide ducking effect when talking over music beds. The screen option permits defining settings for once a show profile load is initiated.

- Check box on each channel assigns the channel to the automix
- Weight drop down provides a priority consideration to the channel in the smart mixing. A weight of 10 is the highest priority where 1 is the lowest.
- Attach Time is a global setting for how quickly the level detector will occur (10ms – 100ms)
- Release Time is a global setting for the level detector to reset (100ms – 1000ms)
- Pre or Post Fader selection designates where in the chain the gain adjust will occur. Sampling always occurs pre the fader.

Phone Screen Options

The Phone screen is used when setting up a Telos talkshow system for use with your console. Please refer to Chapter 5, “Working With Phone Hybrids”, for details. If no Call Controller module is installed, this screen will be empty.

Source Profile

Line and Computer Player

Line and Computer Player types are the basic source types. The functions defined here are true to all other source types.

Source Profile:

Source type:	Line		
Source name:			
Source name override:	Show sourcename		
Primary source:	0		
Signal mode:	Stereo <input type="checkbox"/> Locked		
Signal phase:	Normal		
Signal mode for Record bus:	Stereo		
Fader trim gain (-25 .. 25 dB):	+0.0 dB <input type="checkbox"/> Locked		
Panorama position (-24 .. 24):	0		
<input type="checkbox"/> Equalizer:			
Band:	Low (20 .. 320 Hz)	Mid (125 .. 2000 Hz)	High (1250 .. 20000 Hz)
Frequency:	25 Hz	1000 Hz	16000 Hz
Gain (-25 .. 15 dB):	+0.0 dB	+0.0 dB	+0.0 dB
Mode:	Auto	Peak	Shelf
Source availability:			
<input checked="" type="checkbox"/> Channel 1	<input checked="" type="checkbox"/> Channel 2	<input checked="" type="checkbox"/> Channel 3	<input checked="" type="checkbox"/> Channel 4
<input checked="" type="checkbox"/> Channel 5	<input checked="" type="checkbox"/> Channel 6	<input checked="" type="checkbox"/> Channel 7	<input checked="" type="checkbox"/> Channel 8
			<input checked="" type="checkbox"/> CR Monitor
			<input checked="" type="checkbox"/> St Monitor
Fader mode:	Normal		
Preview mode:	Pre-Fader (CUE)		
Preview switching:	<input type="checkbox"/> Channel ON turns Preview OFF <input type="checkbox"/> Preview ON turns Channel OFF <input type="checkbox"/> Enabled		
Auto-start timer:	<input type="checkbox"/> Enabled		
Logic port:	Exclusive mode <input type="checkbox"/> GPIO ready enabled		
Knob function:	Fader Trim Level		
Flexible Record Mode Options:			
	On Entering		On Exiting
Source:	Retain	Retain	Retain
On switch:	Retain	Retain	Retain
Program 1:	Retain	Retain	Retain
Program 2:	Retain	Retain	Retain
Program 3:	Retain	Retain	Retain
Program 4:	Retain	Retain	Retain
Auxiliary A:	Retain	Retain	Retain
Auxiliary B:	Retain	Retain	Retain
Auxiliary C:	Retain	Retain	Retain
Auxiliary D:	Retain	Retain	Retain
<input type="button" value="Save as Copy"/> <input type="button" value="Apply"/> <input type="button" value="Ok"/> <input type="button" value="Cancel"/>			

Source name:

- 10 character name to be displayed to the console operator.

Source name override:

- Three options. *Show sourcename* will display to the console operator the name applied in Source name (previous item).
- *Allow application to override* will permit the display to change based on the LABL value of the source. Not an option on devices that do not support the LABL property. The LABL property is available on port 93 of the device.

LOGIN

SRC # LABL:"XCharacter"

SRC # LABL:"" (to restore Source name)

Show both will show both the Source name and application controlled LABL property at the same time.

Primary source:

- The Livewire channel identification field. Type the channel number in or use the browse button to search for the source in the network.

Signal mode:

- *Stereo*: stereo signal as is (default)
- *Left*: left channel of stream only
- *Right*: right channel of stream only
- *Sum L+R*: sum left and right into mono

Locked (checkbox):

- if locked, control operator does not have option to change source mode from the surface. The mode is locked.

Signal phase:

- *Normal*: No modification of phase
- *Invert left*: reverse the polarity of the left channel
- *Invert right*: reverse the polarity of the right channel
- *Invert left and right*: reverse polarity of the left and right channel

Signal mode for Record bus:

- *Stereo*: The source will be active as a stereo source on the Program 4 Record mix.
- *If Phone or Codec Left, otherwise Right*: The source will be active on the right channel for 2 channel phone recordings on Program 4 Record mix.
- *Summed-Mono to Left*: The source will be active on the left channel of Program 4 Record mix.
- *Summed-Mono to Right*: The source will be active on the right channel of the Program 4 Record mix.

Fader trim gain (-25 .. 25 dB):

Pre-fader trim gain attribute. The trim gain will allow the adjustment of the signal level at the input of the fader. This can serve for compensation of a too low or high level, or shifting the normal operation point on the fader scale.

Panorama position (-24 .. 24):

Channel's "panorama" attribute will determine the initialization position of the PAN control at source loading. There are 24 steps in either direction. -24 is full pan to the left (3dB gain to left content and right content off). Each step away from 0 (unchanged imaging) is a tenth of a dB change.

Equalizer:

Three bands of control known as Low, Mid, and High. Low band covers the range from 20 hertz to 320 hertz. Mid band covers the range from 125 through 2000 hertz. The high band range is 1250 through 20000 hertz. The center frequency of each band is defined and gain value is defined. The bandwidth control is based on gain applied. This is known as quasi-parametric. The Low mode is a function of the low band gain value, therefore cannot be set. The High mode can be set as either shelf or peak. The shelf option will maintain the gain from the center frequency to the end of the band. The peak option will return the gain to 0 at the end of the band; therefore bandwidth will be dependent on the gain applied.

Source availability:

All surface channels and monitor locations are shown and permit (check) or not permit (no check) the source from being loaded. By default all options are checked at source creation. *Note: If additional faders are added after profile creation, the profile needs to be edited in order for the source to be permitted to new channels.* Starting in version 3.2, there is an "All Channels" option which will toggle the selection of all channels (one click vs many clicks).

Fader mode:

- *Normal* mode the channel status will follow the channel On/Off buttons, independent of fader position.
- *Fader Start* mode the channel status is defined by the fader position. Pushing the fader to the bottom position will turn the channel off, and moving the fader up from the bottom will turn the channel on.
- *Fader Start with Arm* mode is a combination of the two. Channel status is defined by the fader position as long as the channel is armed. The arm state is controlled by the On/Off buttons. In this mode, when the fader is down and armed, both the ON and OFF buttons will be illuminated with the ON button winking (a momentary lack of illumination). Otherwise, the ON and OFF buttons indicate the channel status.

Preview mode:

- *Pre-Fader (CUE)* mode assigns the source to the Preview mix at unity gain.
- *Post-Fader (SOLO)* mode assigns the source to the Preview mix post fader. The audio level going to the preview mix will be controlled by the position of the fader.

Preview switching:

- *Channel ON turns Preview OFF* will remove the source from the Preview mix when the channel is in the ON state.
- *Preview ON turns Channel OFF* will change the state of the channel to OFF when engaging the channel to Preview.

Auto-start timer:

Designates the source to control the count up timer. How the count up timers is controlled is an option in the source profile. If enabling this option and not seeing any changes to the timer, check show profile settings and reload the profile.

Logic port:

- *Exclusive mode* defines that only the channel that has “ownership” of the source controls the logic states of the source. If a channel does not have “ownership”, it is in Listen Only mode and has no control of GPIO or other logical controls (Phone control).
- *Shared mode* defines that the channel can participate in logical control of the source even if not having ownership of the source.
- *Disabled mode* defines that the channel will not attempt to control logical states of the source. *Note that some common sources shared amongst studios have no logic control needs and you may opt to select this mode in order to remove the “Listen Only” indication from the surface.*
- *GPIO ready* is a function used with GPIO to indicate the source is in a ready state. With this enabled, the OFF button will not illuminate unless the corresponding READY command is triggered. Refer to the GPIO information with the source type. *Example: Line type has a READY command at pin 15 and indicates that OFF lamp is illuminated with the triggering of this GPI.*

Knob function:

defines the behavior of the knob at the top of the channel when the channel is not in option mode.

- *Fader Trim Level* mode provides gain adjustment to the channel post fader .
- *PreAmp Gain Adjust* mode will cause the knob to control the pre-amp gain at the source if the source supports the Livewire control protocol. A maximum of 8 is allowed at one time.
- *None* mode disables functionality.
- *Automix Control* provides quick control to enable a channel into the Automix function and to adjust the weight of the channel . When selected, a knob clockwise rotation will enable the channel into automix and a counter clockwise rotation will disable. To adjust the weight of an enabled channel, press the knob in and rotate the knob (while maintaining the downward press).

Flexible Record Mode Options:

	On Entering	On Exiting
Source:	Retain ▼	Retain ▼
On switch:	Retain ▼	Retain ▼
Program 1:	Retain ▼	Retain ▼
Program 2:	Retain ▼	Retain ▼
Program 3:	Retain ▼	Retain ▼
Program 4:	Retain ▼	Retain ▼
Auxiliary A:	Retain ▼	Retain ▼
Auxiliary B:	Retain ▼	Retain ▼
Auxiliary C:	Retain ▼	Retain ▼
Auxiliary D:	Retain ▼	Retain ▼

Flexible Record Mode Options:

The following options permit fairly sophisticated control of the record mode function of Show profiles. The options constitute a matrix of control. There are two columns of control for “Entering” record mode and “Exiting” record mode. Each of the options in the drop downs can be condensed into a retain option, an ON option, an OFF option, or a recall option. The important attributes of a channel are the various rows of options and the matrix is broken down as below. The recall option is a temporary memory of a previous state and is maintained as long as the show is not changed. If the show profile is changed, any recall values should be lost. Also note that the record mode is a function of the show profile and the functionality defined here is dependent on the correct record mode to be enabled.

- *Source:* A retain option will maintain the current loaded source profile as the Record mode is entered or exited. A recall option will recall a previous source. *Example: Define source profile with Recall On Entering and On Exiting. Enter into record mode, change the source on the channel. Exit record mode and the channel will return to the original source profile. Return to record mode and the second source profile will load back.*
- *On switch:* Retain option will preserve the current state as transitioning from record mode or exiting. Turn ON or Turn OFF will force the states. Recall will return the previous state. *Example: Set Recall on Entering and Turn OFF on exiting. This will enable the operator to return to a previous recording state and exit record mode and forcing OFF state to avoid being ON AIR. The same logic should be applied to mix assignments (below).*
- *Program 1, 2, 3, or 4:* Retain option will preserve the current state as transitioning from record mode or exiting. Turn ON or Turn OFF will force the states. Recall will return the previous state. *Example: Any automation sources should likely remain in Retain state on entering or exiting as these sources typically are ON AIR as the operator goes in and out of record mode. You don't want to change these states automatically on the operator.*
- *Auxiliary A, B, C, D:* Options are the same as above with additional options since the Auxiliary mixes include Pre/Post conditions. This means that the Turn ON option is broken down into four different options of Pre-Fader + Pre-Switch, Post-Fader + Pre-Switch, Pre-Fader + Post-Switch, Post-Fader + Post-Switch.

Operator and CR Producer Microphone

Operator microphone source is designed as the control operator or the person using the control surface. Various different talkback functions are built in with the source type and the source is designed for only one to be assigned to the console at a time. The Control Room Producer is similar in setup and has unique GPIO functions that allow the producer to participate in talkback functions with Preview states and GPIO logic. Please refer to the GPIO logic of the CR Producer source type for more information. The Operator and CR Producer source types are similar in options to Line type. If not familiar with those options, please read the section on Line Source type. The added functions to Operator and CR Producer are the Microphone Processing options.

The screenshot shows the 'Microphone Processing' control panel with the following settings:

- Noise Gate:**
 - Threshold (-50 .. 0 dB): +0.0 dB
 - Depth (-30 .. 0 dB): +0.0 dB
- Compressor:**
 - Threshold (-30 .. 0 dB): +0.0 dB
 - Ratio (1:1 .. 16:1): 1.0 :1
 - Freeze Mode:
- De-Esser:**
 - Threshold (-20 .. 0 dB): +0.0 dB
 - Ratio (1:1 .. 8:1): 1.0 :1
- Post-Processing Trim Gain (-20 .. 20 dB):** +0.0 dB

The options can be defined as part of the source profile or may also be defined within Show profiles. Note the Show profile settings will supersede the settings in the source profile. The operator will have dynamic control of these options from the console and the video display as long as the Show profile does not have them locked.

Noise Gate has a check box that, if checked, enables the gate. Threshold setting defines at which audio level the gate begins to open. So an extreme value of 0dB would mean a lot of level would be required whereas the other extreme of -50dB requires very little audio level. The Depth setting defines the amount of reduction applied when the gate is closed.

Compressor has a check box, if checked, enables the compressor. The threshold setting defines at which audio level the compression or audio reduction begins. So the extreme of 0 dB is effectively not doing anything when the other extreme of -30dB enables reduction at the earliest moment within the limits of this function. The Ratio option defines the amount of reduction. Being it is a ratio, equates to the amount entered (in the text field) defines the dB above threshold will turn to 1 dB above threshold. Freeze mode enables a momentary constant of compression to avoid pulsing of gain as the source increases and decrease near the threshold. *Example: A threshold of -15dB and a ratio of 10(1) would mean that a signal of -5dB (relative to 0dBFS) would result into a signal of -14dB.*

De-Esser has a check box, if checked, enables the functionality. The threshold setting defines at what levels of high frequency should attenuation begin. The ratio defines the amount of reduction to occur.

Post-Processing Trim Gain is a gain attribute that is applied post the processing to set a fixed gain value to the dynamic gain attenuation within the dynamics.

CR Guest, Studio Guest, External microphone

The Control Guest, Studio Guest, and External microphone source types are all additional microphones with added functionality built in. Each microphone type is slightly different for the purpose of location, but otherwise the same. CR Guest position is designed for a microphone in the control room, same space as the surface, and will automatically mute the control room monitors. Similar applies for the Studio Guest in that when in the ON state will mute the studio monitors. The External microphone source benefits from the same options as the previous two but will not mute any monitors. All of the source types have unique return feeds to headphones, referred to as backfeeds. This permits the operator the option to press the talkback button on the console and initiate a talkback (IFB) to the microphone position. Many of the options available in this source type follow what has already been defined in the Line type and Operator source types. If not familiar with the options available with those types, please refer to the earlier text for those source types.

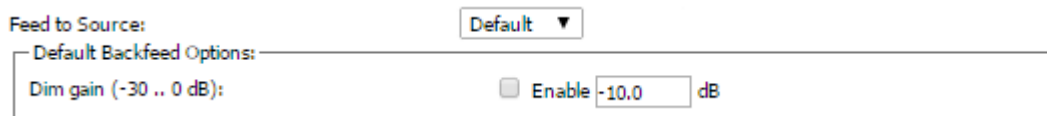

The added option for the three microphone source types is the Feed to Source. There are three options of Disabled, Custom, and Default. Disabled turns off the backfeed audio source and may be required if only interested in getting audio from a source and not generating a return feed. This configuration takes place when juggling ownership between consoles. The Custom option will be explored later. The Default option is the basic operation option. The one control point shown is the dim option which attenuates the normal audio feed to the headphone when a Talkback state is initiated. Select the check box and define the desired attenuation needed allowing the producer or control operator's cues to be heard by the microphone position. The normal audio content heard in the headphone is defined in the Show profile. Each channel in the Show profile has an Individual headphone set point. The default source is to duplicate Studio Monitor audio (without muting). This can be changed as well as define what audio source feeds the Studio Monitors from the Show profile. Please refer to Show profile options for more details.

Feed to Source: Custom ▾

Custom Backfeed Options:

External Feed Src:	0	
IFB Gain (-25 .. 25 dB):	+0,0 dB	
	Left	Right
Feed Volume (-100 .. 0 dB):	<input checked="" type="checkbox"/> Enable +0,0 dB	<input checked="" type="checkbox"/> Enable +0,0 dB
Feed Mode:	M-1 Left ▾	M-1 Left ▾
While Channel is OFF		
Feed Source:	Disconnected ▾	Disconnected ▾
Talk Insertion:	<input type="checkbox"/> Enabled	<input type="checkbox"/> Enabled
Dim gain (-30 .. 0 dB):	<input type="checkbox"/> Enable -10,0 dB	<input type="checkbox"/> Enable -10,0 dB
While Channel is OFF, but in Preview		
Feed Source:	Disconnected ▾	Disconnected ▾
Talk Insertion:	<input type="checkbox"/> Enabled	<input type="checkbox"/> Enabled
Dim gain (-30 .. 0 dB):	<input type="checkbox"/> Enable -10,0 dB	<input type="checkbox"/> Enable -10,0 dB
While Channel is ON		
Feed Source:	Disconnected ▾	Disconnected ▾
Talk Insertion:	<input type="checkbox"/> Enabled	<input type="checkbox"/> Enabled
Dim gain (-30 .. 0 dB):	<input type="checkbox"/> Enable -10,0 dB	<input type="checkbox"/> Enable -10,0 dB
Record Mode: While Channel is OFF		
Feed Source:	Disconnected ▾	Disconnected ▾
Talk Insertion:	<input type="checkbox"/> Enabled	<input type="checkbox"/> Enabled
Dim gain (-30 .. 0 dB):	<input type="checkbox"/> Enable -10,0 dB	<input type="checkbox"/> Enable -10,0 dB
Record Mode: While Channel is OFF, but in Preview		
Feed Source:	Disconnected ▾	Disconnected ▾
Talk Insertion:	<input type="checkbox"/> Enabled	<input type="checkbox"/> Enabled
Dim gain (-30 .. 0 dB):	<input type="checkbox"/> Enable -10,0 dB	<input type="checkbox"/> Enable -10,0 dB
Record Mode: While Channel is ON		
Feed Source:	Disconnected ▾	Disconnected ▾
Talk Insertion:	<input type="checkbox"/> Enabled	<input type="checkbox"/> Enabled
Dim gain (-30 .. 0 dB):	<input type="checkbox"/> Enable -10,0 dB	<input type="checkbox"/> Enable -10,0 dB

The Custom option permits ultimate configuration of the backfeed. The matrix of options is control of the left channel and right channel individually during several channel state conditions.

- *External Feed Src* is a Livewire source which is external to the native mixes present in the DSP Engine. Each of the channel states permit selecting a source to monitor and most of them are mixes native to the DSP Engine. The External option is the source defined in this field.
- *IFB Gain* is a gain stage for any talkback states going to this backfeed. The gain stage permits amplification of the IFB source or attenuation of IFB source. This is a static setting and assumes all sources of talkback would be normalized to a common level.
- *Feed Volume* defines gain value for the audio source normally feeding the backfeed and permits attenuation. Value of 0dB is no attenuation. The check box enabled the audio channel. If the desire is to not have a right channel, unselecting will disable the right channel.
- *Feed Mode* offers options which define the audio feeding the left or right channels. *M-1* indicates mix-minus of the source. The *M-1* options permit defining the left or right of a stereo feed or a mono sum. The other three options are the *Full mix* from the left, right, or the mono sum. *Example: If you have a host that is deaf in one ear, configure both the Left and Right channels for a Full mix mono sum so that the good ear will always get the stereo content.*

- *Feed Source* option is available for each of the six different channel states for the Left and for the Right. The six different states are channel OFF, channel in Preview state, Channel ON state, and the three repeated when in record mode. For each of the 6 states you define the audio content of the left and right channel. The options are the 10 mixes that channels can feed into (Program 1-4, Aux send A-D, Program 4 Record, and Phone mix), the Preview mix, the Studio Monitor mix, or the external source defined earlier. A common source for headphone feeds is the Studio Monitor mix and is what is used when using the default method. If the workflow requires monitoring of other sources, the custom option permits this selection along with changing the source as states change on the channel.
- *Talk Insertion* defines if audio is fed to the backfeed during a channel state. *Example: Do not check the Enable option during Channel is ON to disable the host from being interrupted by Talkback audio while they are live.*
- *Dim gain* is the attenuation of the audio content will experience when a talkback is engaged. The check box should be checked to enable the dim function. *Example: If Talk Insert is not enabled during Channel is ON, a Dim gain value can be used to attenuate the host feed in order to signal but not interrupt the content. Also the dimming is helpful if Talk insert is enabled in order to give prominence to the Talkback audio.*

Codec

Codec source type has the same options as the guest microphone source type with change in Feed to source options. An additional change is in built in GPIO functionality. GPIO functionality is defined in the section dedicated to GPIO. If not familiar with the options for a guest microphone, please refer to the previous text. The following text will introduce the different feed to source behavior for the codec type.

The image shows a configuration window for a codec source. It contains the following elements:

- Feed to Source:** A dropdown menu currently set to "Default".
- Default Backfeed Options:** A section containing:
 - Dim gain (-30 .. 0 dB):** A checkbox labeled "Enable" is checked, followed by a text input field containing "-10.0" and a unit label "dB".
 - Feed Source:** A dropdown menu currently set to "Auto (Program 1 / Phone)".

The default backfeed option for a codec source type is similar to the guest microphone with dim control with the inclusion of feed to source option. A codec is assumed to require a mix-minus which is a mix of audio minus the source itself. The DSP engine has many mixes and the *Feed Source* option permits the selection of one of those mixes which will feed the codec, minus the codec itself. In the drop down are 8 standard console mixes known as Program 1-4 and Aux Send A-D. An additional option listed is the Phone mix. The Phone mix is a special mix which is enabled through the Program 4 button and behaves as a Pre-fader and Pre-switch mix. Any channel with the Program 4 button illuminated will have the source audio active at unity gain in the Phone mix. The intention here is for easy Off-line talking with remote sources and is a typical workflow with phone callers. This is what the mix is called Phone. The default option in the drop down is *Auto (Program 1 / Phone)* which is another special behavior in Axia consoles that allows for automatic switching of the mix-minus based on the On state of the channel. When the channel where the codec source type is loaded is in the Off state, the mix-minus will be the Phone mix. When the channel is in the On state, the mix-minus is the Program 1 mix. The change happens automatically based on the channel state and is always minus the codec source. The intention with the feature is when the source is Off easy communication can occur and when the source is On the source is ON AIR and should receive a mix-minus which represent the ON AIR content (typically Program 1). If you wish the mix minus to always be Program 1, select Program 1 from the drop down list.

As with the guest microphone type, the codec type has the custom option for the feed to source. This permits the custom building of the return feed to a codec. The image below present the rebuilding of the default behavior through the custom options.

Custom Backfeed Options:

External Feed Src:	0	
IFB Gain (-25 .. 25 dB):	+0.0 dB	
Feed Volume (-100 .. 0 dB):	<input checked="" type="checkbox"/> Enable +0.0 dB	<input checked="" type="checkbox"/> Enable +0.0 dB
Feed Mode:	M-1 Mono Sum	M-1 Mono Sum
While Channel is OFF		
Feed Source:	Phone	Phone
Talk Insertion:	<input checked="" type="checkbox"/> Enabled	<input type="checkbox"/> Enabled
Dim gain (-30 .. 0 dB):	<input checked="" type="checkbox"/> Enable -10.0 dB	<input type="checkbox"/> Enable -10.0 dB
While Channel is OFF, but in Preview		
Feed Source:	Phone	Phone
Talk Insertion:	<input checked="" type="checkbox"/> Enabled	<input type="checkbox"/> Enabled
Dim gain (-30 .. 0 dB):	<input checked="" type="checkbox"/> Enable -10.0 dB	<input type="checkbox"/> Enable -10.0 dB
While Channel is ON		
Feed Source:	Program 1	Program 1
Talk Insertion:	<input checked="" type="checkbox"/> Enabled	<input type="checkbox"/> Enabled
Dim gain (-30 .. 0 dB):	<input checked="" type="checkbox"/> Enable -10.0 dB	<input type="checkbox"/> Enable -10.0 dB
Record Mode: While Channel is OFF		
Feed Source:	Phone	Phone
Talk Insertion:	<input checked="" type="checkbox"/> Enabled	<input type="checkbox"/> Enabled
Dim gain (-30 .. 0 dB):	<input checked="" type="checkbox"/> Enable -10.0 dB	<input type="checkbox"/> Enable -10.0 dB
Record Mode: While Channel is OFF, but in Preview		
Feed Source:	Phone	Phone
Talk Insertion:	<input checked="" type="checkbox"/> Enabled	<input type="checkbox"/> Enabled
Dim gain (-30 .. 0 dB):	<input checked="" type="checkbox"/> Enable -10.0 dB	<input type="checkbox"/> Enable -10.0 dB
Record Mode: While Channel is ON		
Feed Source:	Program 1	Program 1
Talk Insertion:	<input checked="" type="checkbox"/> Enabled	<input type="checkbox"/> Enabled
Dim gain (-30 .. 0 dB):	<input checked="" type="checkbox"/> Enable -10.0 dB	<input type="checkbox"/> Enable -10.0 dB

What can be observed that the default backfeed is a mix-minus mono sum on the 2 channels with talkback only on the left channel. The default nature is intended with the workflow that a remote would have the first channel as the remote talent feed (with talkback) and the second channel as a PA feed without talkback enabled. With the custom option, you can introduce a stereo return feed with dual channel talkback by selecting the M-1 Left and M-1 Right and enabling all Talk insert check boxes.

Phone

Phone source type is similar in options as codec with the inclusion of Phone control options and different built in GPIO behavior. Refer to GPIO section for defined GPIO functionality. Review the codec options if not already familiar.

Phone Control:

No Phone Control

EU Phone:

Server IP:

Telos 2:
Line:

AP (Nx12):
 Use 2nd show (split)
Line:
Hybrid:

Vx:
Studio name:
Fixed Hybrid:

In a console without a call controller module, the option to connected to a Telos based IP phone system is through the use of EU Phone mode. In EU Phone mode, the connection is done such that a dedicated hybrid is assigned to the source. *Example: With a Telos VX, a VX Studio can have Fixed Channels created. If done, the EU Phone configuration would have the VX IP address in the Server IP field, the VX check box selected, the studio name as defined in the VX and which of the fixed hybrids to use.*

Phone Control:

No Phone Control

EU Phone:

Server IP:

Telos 2:
Line:

AP (Nx12):
 Use 2nd show (split)
Line:
Hybrid:

Vx:
Studio name:
Fixed Hybrid:

US Phone:

Call Controller 1
Hybrid:
Fixed Line:
 Mashing allowed

In the case that a call controller is installed, the presentation of the Phone source type will contain the EU Phone option and the US Phone option. The US Phone options is to select the *Call Controller 1* (multiple Call controllers will appear if there are more), define the *Hybrid* number (this is 1 or 2 in most cases). Fixed Line option is a legacy item for interfacing with older Telos systems and creating dedicated hybrid/line associations. This is a deprecated function and may be removed in future versions. Mashing allowed is the option of assigning multiple callers to a single hybrid.

The above items are for configuration with Telos IP based phone solutions. If using a phone system from a different vendor or using HX1 or similar Telos product, the option of control would be with GPIO. The additional item available in Phone source type is the answer mode options. This drop down controls the GPIO functionality with the source and is intended for single line hybrids that use GPIO for control.

Hybrid answer mode:

Normal, auto answer disabled ▼

The options of *Channel ON answers hybrid* or *Channel ON or Preview ON answers hybrid* will engage the GPIO functionality based on the state of the channel. The default option of disabled will prevent the GPIO from acting. If using a GPIO controlled hybrid, make sure to select the needed hybrid mode.

Appendix B:

Configuring GPIO

The Axia IP-Audio system is capable of transporting routable machine logic along with each audio signal. Unlike conventional logic connections which require each command circuit to be wired individually, Axia sends machine controls over the same Ethernet your upon which your audio travels.

Fusion's GPIO capabilities provide control of external audio devices, logic commands for routine studio/control room operations such as tally lights, monitor muting, On-Air lights and more, and even "virtual" GPIO for routing system commands, using Axia Pathfinder routing controls tools.

This Appendix provides a fast overview of these GPIO functions. Please refer to the [Axia xNode User's Manual](#) for more in-depth information on configuring GPIO.

GPIO Port Definitions

Axia PowerStation mix engines feature 4 built-in GPIO connections; Fusion consoles using StudioEngine mix engines must be paired with xNode GPIO Nodes. Each

GPIO port can be associated with a device in your studio, and provides five opto- isolated inputs and five opto-isolated outputs per device.

GPIO ports are pre-programmed to support several different types of devices; when you construct Source Profiles, the GPIO type best suited for the Source Type you choose is associated with that Profile. When the source is assigned to a console fader, this Source Profile selection tells the GPIO port what sort of command to send to the attached device.

If the Source Profile defines the attached device as a microphone, the GPIO port sends logic for On, Off, Remote Mute and Remote Talk commands on the appropriate pins. If the Source Profile is configured for a line input, the GPIO port sends Start, Stop and Reset commands, plus closures for Ready lights, etc.

Axia GPIO ports can deliver unique command sets for the following types of devices:

1. Microphone (Operator, Guest or Producer)
2. Line Input
3. Codec
4. Telephone Hybrid
5. Computer Playback Device
6. Control Room Monitor
7. Studio Monitor
8. Accessory Button Panel Device

The next few pages contain tables that explain what function the GPIO port pins provide in each different device mode.

GPIO Operator's Microphone Logic

Name	Pin	Type	Notes
INPUTS			
ON Command	11	Active Low Input	Turns channel ON
OFF Command	12	Active Low Input	Turn channel OFF
TALK (to Monitor 2) Command	13	Active Low Input	Activates the TALK TO MON2 function and routes mic audio to the Talkback bus.
MUTE Command	14	Active Low Input	Mutes channel outputs
TALK (to PREVIEWED SOURCE) Command	15	Active Low Input	Activates the TALK button on every source currently in preview and routes mic audio to the Talkback bus.
OUTPUTS			
ON Lamp	1	Open Collector to Logic Common Return	Illuminates when channel is ON unless TALK or MUTE is active
OFF Lamp	2	Open Collector to Logic Common Return	Illuminates when channel is OFF
TALK (to Monitor 2) Lamp	3	Open Collector to Logic Common Return	Illuminates when TALK TO MON2 is active
MUTE Lamp	4	Open Collector to Logic Common Return	Illuminates when MUTE is active
TALK (to PREVIEWED SOURCE) Lamp	5	Open Collector to Logic Common Return	Illuminates when TALK to PREVIEWED SOURCE is active.
POWER & COMMON			
Source Common	7	Logic Common	Connect to ground of source device or to Pin 8
Logic Common	8	Internal 5 Volt return	Can be connected to Pin 7 if source is not providing common
Logic +5 Volt Supply	9	Logic Supply, Individually Fused	Can be connected to Pin 10 if source is not providing voltage; active only when source has been assigned to channel.
Input Common	10	Common for all 5 inputs	Connect to power supply of source device or to Pin 9
NOT CONNECTED	6		

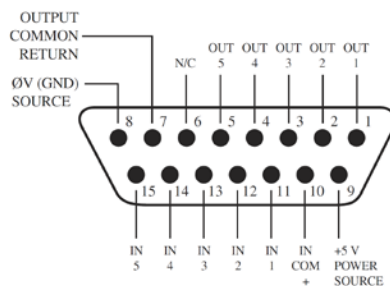

GPIO Control Room Guest Microphone Logic

Name	Pin	Type	Notes
INPUTS			
ON Command	11	Active Low Input	Turns channel ON
OFF Command	12	Active Low Input	Turn channel OFF
TALK (to CR) Command	13	Active Low Input	Mutes channel outputs and routes source audio to PVW speakers
MUTE Command	14	Active Low Input	Mutes channel outputs
NOT CONNECTED	15		
OUTPUTS			
ON Lamp	1	Open Collector to Logic Common Return	Illuminates when channel is ON unless TALK or MUTE is active
OFF Lamp	2	Open Collector to Logic Common Return	Illuminates when channel is OFF
TALK (to CR) Lamp	3	Open Collector to Logic Common Return	Illuminates when TALK is active
MUTE Lamp	4	Open Collector to Logic Common Return	Illuminates when MUTE is active
NOT CONNECTED	5		
POWER & COMMON			
Source Common	7	Logic Common	Connect to ground of source device or to Pin 8
Logic Common	8	Internal 5 Volt return	Can be connected to Pin 7 if source is not providing common
Logic + 5 Volt supply	9	Logic Supply, Individually Fused	Can be connected to Pin 10 if source is not providing voltage; active only when source has been assigned to channel.
Source Supply	10	Common for all 5 inputs	Connect to power supply of source device or to Pin 9
NOT CONNECTED	6		

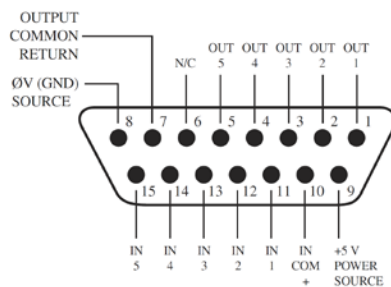

GPIO Producer's Microphone Logic

Name	Pin	Type	Notes
INPUTS			
ON Command	11	Active Low Input	Turns channel ON
OFF Command	12	Active Low Input	Turn channel OFF
TALK (to MONITOR 2) Command	13	Active Low Input	Activates the TALK to MON2 function and routes mic audio to the Talkback bus.
MUTE Command	14	Active Low Input	Mutes channel outputs
TALK (to PREVIEWED SOURCE) Command	15	Active Low Input	Activates the TALK button on every source currently in Preview and routes mic audio to the Talkback bus.
OUTPUTS			
ON Lamp	1	Open Collector to Logic Common Return	Illuminates when channel is ON unless TALK or MUTE is active
OFF Lamp	2	Open Collector to Logic Common Return	Illuminates when channel is OFF
TALK (to MONITOR 2) Lamp	3	Open Collector to Logic Common Return	Illuminates when TALK to MON2 is active.
MUTE Lamp	4	Open Collector to Logic Common Return	Illuminates when MUTE is active
TALK (to PREVIEWED SOURCE) Lamp	5	Open Collector to Logic Common Return	Illuminates when TALK to PREVIEWED SOURCE is active.
POWER & COMMON			
Source Common	7	Logic Common	Connect to ground of source device or to Pin 8
Logic Common	8	Internal 5 Volt return	Can be connected to Pin 7 if source is not providing common
Logic + 5 Volt supply	9	Logic Supply, Individually Fused	Can be connected to Pin 10 if source is not providing voltage; active only when source has been assigned to channel.
Source Supply	10	Common for all 5 inputs	Connect to power supply of source device or to Pin 9
NOT CONNECTED	6		

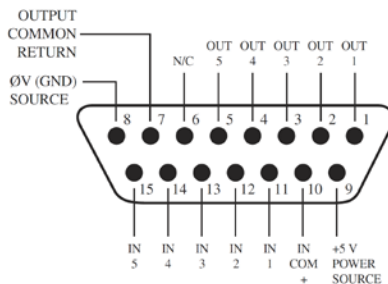

GPIO Line Input Logic

Name	Pin	Type	Notes
INPUTS			
ON Command	11	Active Low Input	Turns channel ON
OFF Command	12	Active Low Input	Turns channel OFF & sends 100 msec STOP pulse
PREVIEW Command	13	Active Low Input	Turns preview ON
RESET Command	14	Active Low Input	Turns channel OFF, while not sending a STOP pulse
READY Command	15	Active Low Input	Illuminates OFF lamp to indicate source's readiness
OUTPUTS			
ON Lamp	1	Open Collector to Logic Common Return	Illuminates when channel is ON
OFF Lamp	2	Open Collector to Logic Common Return	Illuminates when channel is OFF and READY is active
PREVIEW Lamp	3	Open Collector to Logic Common Return	Illuminates when PREVIEW is ON
START Pulse	4	Open Collector to Logic Common Return	A 100 msec pulse when the channel status changes from OFF to ON
STOP Pulse	5	Open Collector to Logic Common Return	A 100 msec pulse when the channel status changes from ON to OFF
POWER & COMMON			
Source Common	7	Logic Common	Connect to ground of source device or to Pin 8
Logic Common	8	Internal 5 Volt return	Can be connected to Pin 7 if source is not providing common
Logic + 5 Volt supply	9	Logic Supply, Individually Fused	Can be connected to Pin 10 if source is not providing voltage; active only when source has been assigned to channel.
Source Supply	10	Common for all 5 inputs	Connect to power supply of source device or to Pin 9
NOT CONNECTED	6		

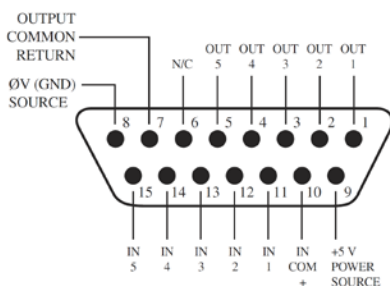

GPIO Codec Logic

Name	Pin	Type	Notes
INPUTS			
ON Command	11	Active Low Input	Turns channel ON
OFF Command	12	Active Low Input	Turns channel OFF
TALK (to CR) Command	13	Active Low Input	Mutes channel outputs and routes source audio to PVW speakers
MUTE Command	14	Active Low Input	Mutes channel outputs
TALK (to SOURCE) Command	15	Active Low Input	Allows an external button to activate channel TALK TO SOURCE function.
OUTPUTS			
ON Lamp	1	Open Collector to Logic Common Return	Illuminates when channel is ON unless TALK or MUTE are active
OFF Lamp	2	Open Collector to Logic Common Return	Illuminates when channel is OFF.
TALK (to CR) Lamp	3	Open Collector to Logic Common Return	Illuminates when TALK is active
MUTE Lamp	4	Open Collector to Logic Common Return	Illuminates when MUTE is active
TALK (to SOURCE) Lamp	5	Open Collector to Logic Common Return	Illuminates when the channel TALK TO SOURCE function is active.
POWER & COMMON			
Source Common	7	Logic Common	Connect to ground of source device or to Pin 8
Logic Common	8	Internal 5 Volt return	Can be connected to Pin 7 if source is not providing common
Logic + 5 Volt supply	9	Logic Supply, Individually Fused	Can be connected to Pin 10 if source is not providing voltage; active only when source has been assigned to channel.
Source Supply	10	Common for all 5 inputs	Connect to power supply of source device or to Pin 9
NOT CONNECTED	6		

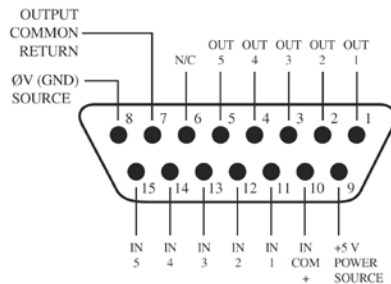

GPIO Telephone Hybrid Logic

Name	Pin	Type	Notes
INPUTS			
ON Command	11	Active Low Input	Turns channel ON
OFF Command	12	Active Low Input	Turns channel OFF
PREVIEW Command	13	Active Low Input	Turns preview ON
RESET Command	14	Active Low Input	Turns channel off while not sending a STOP pulse
READY Command	15	Active Low Input	Illuminates OFF lamp to indicate source's readiness
OUTPUTS			
ON Lamp	1	Open Collector to Logic Common Return	Illuminates when channel is ON
OFF Lamp	2	Open Collector to Logic Common Return	Illuminates when channel is OFF
PREVIEW Lamp	3	Open Collector to Logic Common Return	Illuminates when PREVIEW is ON
START Pulse	4	Open Collector to Logic Common Return	A 100 ms PULSE is sent when channel is first turned ON or when PVW is first selected
STOP Pulse	5	Open Collector to Logic Common Return	A 100 ms PULSE sent when channel is turned OFF.
POWER & COMMAND			
Source Common	7	Logic Common	Connect to ground of source device or to Pin 8
Logic Common	8	Internal 5 Volt return	Can be connected to Pin 7 if source is not providing common
Logic + 5 Volt supply	9	Logic Supply, Individually Fused	Can be connected to Pin 10 if source is not providing voltage; active only when source has been assigned to channel.
Source Supply	10	Common for all 5 inputs	Connect to power supply of source device or to Pin 9
NOT CONNECTED	6		

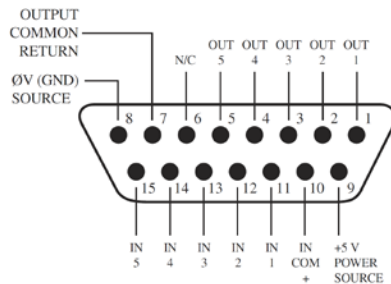

GPIO Control Room Monitor Logic

Name	Pin	Type	Notes
INPUTS			
MUTE CR Command	11	Active Low Input	Mutes CR monitors and Pre-view speakers
DIM CR Command	12	Active Low Input	Allows external dimming of CR monitor speakers.
Enable EXT PREVIEW Command	13	Active Low Input	Feeds External Audio Input to PREVIEW
TALK TO EXT Command	14	Active Low Input	Turns on Talk to External Audio.
Not used.	15	Active Low Input	
OUTPUTS			
CR ON AIR Lamp	1	Open Collector to Logic Common Return	Illuminates whenever CR monitors are muted
DIM CR Lamp	2	Open Collector to Logic Common Return	Illuminates whenever control room monitors are DIMMED
PREVIEW Lamp	3	Open Collector to Logic Common Return	Illuminates when PREVIEW is active.
TALK TO EXT Lamp	4	Open Collector to Logic Common Return	Illuminates when Talk to External is active.
TALK (to CR) Active Lamp	5	Open Collector to Logic Common Return	Active whenever a source has activated its TALK (to CR) function
POWER & COMMON			
Source Common	7	Logic Common	Connect to ground of source device or to Pin 8
Logic Common	8	Internal 5 Volt return	Can be connected to Pin 7 if source is not providing common
Logic + 5 Volt supply	9	Logic Supply, Individually Fused	Can be connected to Pin 10 if source is not providing voltage; active only when source has been assigned to channel.
Source Supply	10	Common for all 5 inputs	Connect to power supply of source device or to Pin 9
NOT CONNECTED	6		

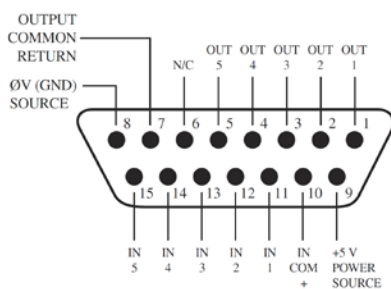

GPIO Computer Playback Device Logic

Name	Pin	Type	Notes
INPUTS			
ON Command	11	Active Low Input	Turns channel ON
OFF Command	12	Active Low Input	Turns channel OFF & sends 100 msec STOP pulse
PREVIEW Command	13	Active Low Input	Turns preview ON
Not Used	14	Active Low Input	
READY Command	15	Active Low Input	Illuminates OFF lamp to indicate source's readiness
OUTPUTS			
NEXT Pulse	1	Open Collector to Logic Common Return	A 100 mS PULSE sent when ON button is depressed, except when initially turned ON.
OFF Lamp	2	Open Collector to Logic Common Return	Illuminates when channel is OFF and READY is active
PREVIEW Lamp	3	Open Collector to Logic Common Return	Illuminates when PREVIEW is ON
START Pulse	4	Open Collector to Logic Common Return	A 100 ms PULSE sent when channel is first turned ON.
STOP Pulse	5	Open Collector to Logic Common Return	A 100 ms PULSE sent when channel is turned OFF.
POWER & COMMON			
Source Common	7	Logic Common	Connect to ground of source device or to Pin 8
Logic Common	8	Internal 5 Volt return	Can be connected to Pin 7 if source is not providing common
Logic + 5 Volt supply	9	Logic Supply, Individually Fused	Can be connected to Pin 10 if source is not providing voltage; active only when source has been assigned to channel.
Source Supply	10	Common for all 5 inputs	Connect to power supply of source device or to Pin 9
NOT CONNECTED	6		

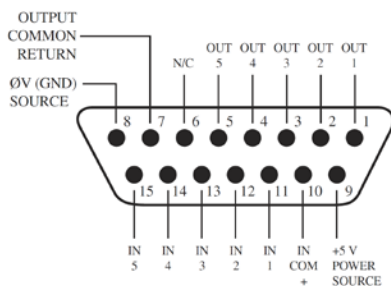

About GPIO Connections

INPUT	
VDC	External Series Resistor
5	0
6	0
12	680 @ 1/4 watt
24	1.8k @ 1/2 watt
48	3.9k @ 1 watt

The maximum voltage allowed for an external power supply for logic control is 48 volts DC. The use of a current limiting resistor is required for some voltages.

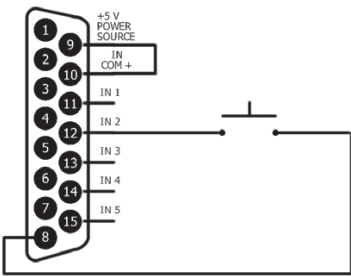

If the equipment being controlled is electrically isolated, than the use of the GPIO port's power supply is acceptable as shown here.

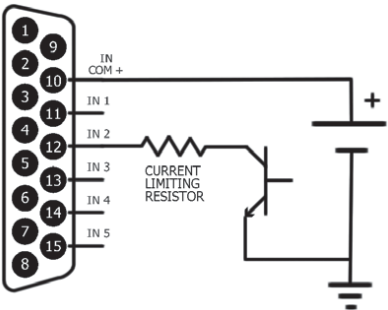

Take note to use current limiting resistors per the above chart if the voltage supplied is above 6vdc. The intention is to limit the current to 20mA for each GPI pin.

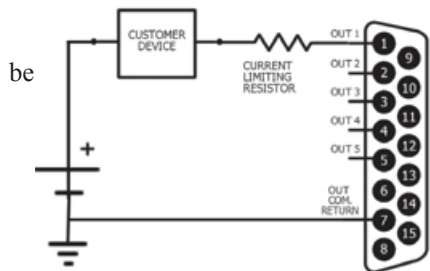

The GPO portion of the GPIO ports are solid state relays. Current should be limited to a combined 100mA through all the pins of a port. Maximum allowed voltage is 24 volts. The following diagram shows the recommended connections for outputs with the use of an external power supply.

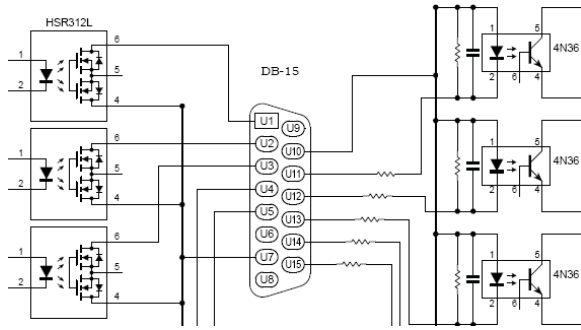

The Axia accessory modules use the 5vDC supply to illuminate LED based buttons. So a one-to-one pin connection is all that is needed between any accessory modules and a GPIO port.

Note, all of the inputs and outputs on a specific GPIO port are “grouped together”. The 5 “Outputs” are on 5 separate output pins, however, they share the same “Common Return” connection on Pin #7. Similarly,

the 5 “Inputs” pins would be pulled to ground to activate them, and they share a common pin for a high-side rail, on Pin #10. If more than one remotely-controlled device is to be connected to a single 15-pin I/O port, you must make sure that the two units in question have the same ground potential or ground loops will occur. Therefore, it is recommended that only one remote device be connected to each I/O port connector to assure complete electrical isolation.

Intentionally Left Blank

Appendix C:

Specifications

Microphone Preamplifiers

- Source Impedance: 150 Ohms
- Input Impedance: 4 k Ohms minimum, balanced
- Nominal Level Range: Adjustable, -75 dBu to -20 dBu
- Input Headroom: >20 dB above nominal input
- Output Level: +4 dBu, nominal

Analog Line Inputs

- Input Impedance: >40 k Ohms, balanced
- Nominal Level Range: Selectable, +4 dBu or -10dBv
- Input Headroom: 20 dB above nominal input

Analog Line Outputs

- Output Source Impedance: <50 Ohms balanced
- Output Load Impedance: 600 Ohms, minimum
- Nominal Output Level: +4 dBu
- Maximum Output Level: +24 dBu

Digital Audio Inputs and Outputs

- Reference Level: +4 dBu (-20 dB FSD)
- Impedance: 110 Ohms, balanced (XLR)
- Signal Format: AES-3 (AES/EBU)
- AES-3 Input Compliance: 24-bit with selectable sample rate conversion,
- 32 kHz to 96kHz input sample rate capable.
- AES-3 Output Compliance: 24-bit
- Digital Reference: Internal (network timebase) or external reference 48 kHz,
- +/- 2 ppm
- Internal Sampling Rate: 48 kHz
- Output Sample Rate: 44.1 kHz or 48 kHz
- A/D Conversions: 24-bit, Delta-Sigma, 256x oversampling
- D/A Conversions: 24-bit, Delta-Sigma, 256x oversampling
- Latency <3 ms, mic in to monitor out, including network and processor loop

Frequency Response

- Any input to any output: +0.5 / -0.5 dB, 20 Hz to 20 kHz

Dynamic Range

- Analog Input to Analog Output: 102 dB referenced to 0 dBFS,
- 105 dB “A” weighted to 0 dBFS
- Analog Input to Digital Output: 105 dB referenced to 0 dBFS
- Digital Input to Analog Output: 103 dB referenced to 0 dBFS, 106 dB “A” weighted
- Digital Input to Digital Output: 138 dB

Equivalent Input Noise

- Microphone Preamp: -128 dBu, 150 ohm source, reference -50 dBu input level

Total Harmonic Distortion + Noise

- Mic Pre Input to Analog Line Output: <0.005%, 1 kHz, -38 dBu input, +18 dBu output
- Analog Input to Analog Output: <0.008%, 1 kHz, +18 dBu input, +18 dBu output
- Digital Input to Digital Output: <0.0003%, 1 kHz, -20 dBFS
- Digital Input to Analog Output: <0.005%, 1 kHz, -6 dBFS input, +18 dBu output

Crosstalk Isolation, Stereo Separation and CMRR

- Analog Line channel to channel isolation: 90 dB isolation minimum, 20 Hz to 20 kHz
- Microphone channel to channel isolation: 80 dB isolation minimum, 20 Hz to 20 kHz
- Analog Line Stereo separation: 85 dB isolation minimum, 20Hz to 20 kHz
- Analog Line Input CMRR: >60 dB, 20 Hz to 20 kHz
- Microphone Input CMRR: >55 dB, 20 Hz to 20 kHz

Audio Processing

Equalizer

- Frequency Bands: 20Hz to 320Hz, 125Hz to 2KHz, 1.25KHz to 20KHz.
- Cut/Boost range on each band: -25dB to +15dB.
- Q-factor: Automatic - bandwidth varies based on amount of cut or boost.

Compressor

- Threshold: -30dB to 0dB Ratio: 1:1 to 16:1
- Post-processor Trim Level: Adjustable from -20dB to +20dB

Expander/Noise Gate

- Threshold: -50dB to 0dB Ratio: -30dB to 0dB

De-esser

- Threshold: -20dB to 0dB Ratio: 1:1 to 8:1

Power Supply AC Input, StudioEngine

- Auto-sensing, field-replaceable modular supply, 90VAC to 240VAC, 50 Hz to 60 Hz, IEC receptacle, internal fuse
- Power consumption: 100 Watts

Power Supply AC Input, Element Power Supply/GPIO

- Auto-sensing supply, 90VAC to 240VAC, 50 Hz to 60 Hz, IEC receptacle, internal fuse
- Power consumption: 150 Watts

Power Supply AC Input, PowerStation Aux & Main

- Auto-sensing supply, 90VAC to 240VAC, 50 Hz to 60 Hz, IEC receptacle, internal fuse
- Power consumption: 500 Watts

Operating Temperatures

- -10 degrees C to +40 degrees C, <90% humidity, no condensation

Appendix D

CE Declaration of Conformity



Declaration of Conformity

MANUFACTURER'S DECLARATION OF CONFORMITY

Number: TF4082

Declaration: This product is in conformity with Directive 2006/95/EC of the European Parliament and of the Council of 12 December 2006 on the harmonisation of the laws of Member States relating to electrical equipment designed for use within certain voltage limits (codified version).

This product is in conformity with Directive 2004/108/EC of the European Parliament and of the Council of 15 December 2004 on the approximation of the laws of the Member States relating to electromagnetic compatibility and repealing Directive 89/336/EEC Text with EEA relevance.

Manufacturer: Axia Audio, TLS Corp.
1241 Superior Avenue E,
Cleveland, Ohio 44114 USA

Product Identification:
Model: Fusion Console & PSU

Standards Used :

EN60950-1:2006 +A11:2009 +A1:2010	Information technology equipment – Safety Part 1: General requirements
EN 55103-1:2009	Electromagnetic compatibility - Product family standard for audio, video, audio-visual and entertainment lighting control apparatus for professional use -- Part 1: Emissions
EN 55103-2:2009	Electromagnetic compatibility - Product family standard for audio, video, audio-visual and entertainment lighting control apparatus for professional use -- Part 2: Immunity

Technical File: TF4082

Means of Conformity: Technical File

Signature of Manufacturer:

SCOTT STIEFEL /  / CHIEF OPER OFFICER
Name/Signature/Title

Place: TLS Corp.
1241 Superior Avenue E,
Cleveland, Ohio 44114 USA

Date: 2/23/2015

Intentionally Left Blank

Appendix E:

Warranty

Telos Alliance Limited Warranty

This Warranty covers “the Products,” which are defined as the various audio equipment, parts, software and accessories manufactured, sold and/or distributed by or on behalf of TLS Corp. and its affiliated companies, collectively doing business as The Telos Alliance (hereinafter “Telos”).

With the exception of software-only items, the Products are warranted to be free from defects in material and workmanship for a period of five (5) years from the date of receipt of such Product by the end-user (such date of receipt the “Receipt Date”). Software-only items are warranted to be free from defects in material and workmanship for a period of 90 days from the Receipt Date. Telos will repair or replace (in its discretion) defective Products returned to Telos within the warranty period, subject to the provisions and limitations set forth herein.

This warranty will be void if the Product: (i) has been subjected, directly or indirectly, to Acts of God, including (without limitation) lightning strikes or resultant power surges; (ii) has been improperly installed or misused, including (without limitation) the failure to use telephone and power line surge protection devices; (iii) has been damaged by accident or neglect. As with all sensitive electronic equipment, to help prevent damage and or loss of data, we strongly recommend the use of an uninterruptible power supply (UPS) with all of our Products. Telos products are to be used with registered protective interface devices which satisfy regulatory requirements in their country of use.

This Warranty is void if the associated equipment was purchased or otherwise obtained through sales channels not authorized by Telos.

EXCEPT FOR THE ABOVE-STATED EXPRESS WARRANTY, TELOS MAKES NO WARRANTIES, EXPRESS OR IMPLIED (INCLUDING IMPLIED WARRANTIES OF MERCHANTABILITY AND FITNESS FOR A PARTICULAR PURPOSE).

In no event will Telos, its directors, officers, employees, agents, owners, consultants or advisors (its “Affiliates”), or authorized dealers or their respective Affiliates, be liable for incidental or consequential damages, or for loss, damage, or expense directly or indirectly arising from the use of any Product or the inability to use any Product either separately or in combination with other equipment or materials, or from any other cause.

In order to invoke this Warranty, the Product must be registered via Telos’ website (found at: <http://telosalliance.com/legal/warranty>) at time of receipt by end-user and notice of a warranty claim must be received by Telos within the above stated warranty period and warranty coverage must be authorized by Telos. Contact may be made via email: support@telosalliance.com or via telephone: (+1) 216-241-7225. If Telos authorizes the performance of warranty service, the defective Product must be delivered to: Telos, 1241 Superior Avenue, Cleveland, Ohio 44114 or other company repair center as may be specified by Telos at the time of claim.

Shipping Costs and Warranty Service:

If the date the customer's notice of warranty claim is received by Telos (such date the "Warranty Claim Notice Date") is within the first 90 days following the Receipt Date, Telos will pay the costs of shipping such warranted Product to and from the end user's location, and the cost of repair or replacement of such warranted Product.

If the Warranty Claim Notice Date occurs after the first 90 days following the Receipt Date and before the end of the second (2nd) year, the customer will pay the freight to return the warranted Product to Telos. Telos will then, at its sole discretion, repair or replace the warranted Product and return it to the end user at Telos' expense.

If the Warranty Claim Notice Date occurs between the end of the second (2nd) year following the Receipt Date and the completion of the fifth (5th) year, the customer will pay the costs of shipping such warranted Product to and from the end user's location. Telos will then, in its sole discretion, repair or replace the warranted Product at Telos' expense. Telos also reserves the right, if it is not economically justifiable to repair the warranted Product, to offer a replacement product of comparable performance and condition direct to the customer at a discounted price, accepting the failed warranted Product as a trade-in.

The end user will in all cases be responsible for all duties and taxes associated with the shipment, return and servicing of the warranted Product.

No distributor, dealer, or reseller of Telos products is authorized under any circumstances to extend, expand or otherwise modify in any way the warranty provided by Telos, and any attempt to do so is null and void and shall not be effective as against Telos or its Affiliates.

Out of warranty units returned to the factory for repair may be subject to a \$500 evaluation fee, which fee must be prepaid prior to shipping the unit to Telos. If no repairs are required, the \$500 fee will be retained by Telos as an evaluation charge. If repairs are required, the \$500 fee will be applied to the total cost of the repair.

To activate your product warranty, visit <http://www.telosalliance.com/product-registration> .

Appendix F

New Features

Version 3.2 adds new features to the Fusion console and those features are noted in this Appendix.

- Add Automix Feature.
- Add support for Fader Accessory Panel
- AES67/SIP support

Automix

Within the Show Profile options is Automix. The page provides a view of all the channels on the console (including virtual faders) and allows for enabling that channel to participate in the Automix. If the channel has a source assigned, it will appear in the source column. The last column is the weight drop down which defines the influence the channel will have in the mix. A value of 1 is a low weight and has the least prominence in the mix. A value of 10 is given the greatest prominence. At the bottom are the global settings. The attack time and release time are for level detector operation. Large release times would maintain an attenuated state for the lower weight channels. The gain control applied by the Automix feature is located prior to the fader and the Pre-/Post-Fader switch allows for bypassing the fader or not. A Post fader selection gives the operator control of the mix where a Pre does not.

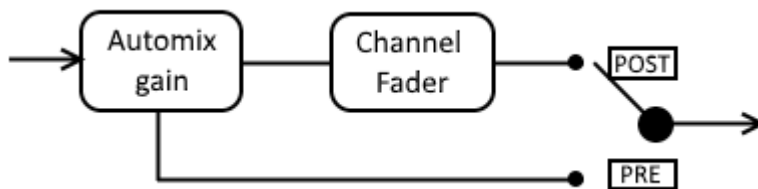

The Show Profile settings apply the Automix on the show load. If settings need to be changed on the fly, there are a few methods to accomplish this. The fastest method is to set the “Knob function” option to “Automix control” within Source Profiles.

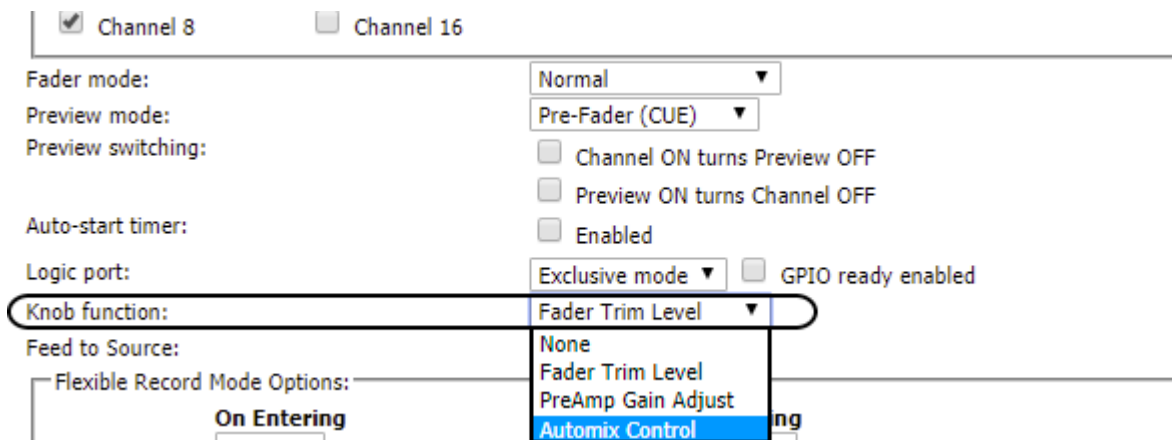

This setting will allow the operator to use the knob at the top of a channel to enable into Automix and adjust the weight. A rotation clockwise will *enable* and a counter-clockwise rotation will *disable* the channel for Automix. A press down and rotate will adjust the weight value of the channel. The channel display will indicate in the top right a square and number for Automix. The number indicates the weight and that the channel is enabled into Automix.

The alternate method to control Automix is to use the Channel option screen. Press the knob of a channel to access options for the channel. Rotate the knob to highlight the Automix and press to select and access the view of option. The Fusion video display will show the channel settings and the global settings. Use the knobs associated with the Master module to select the settings and adjust.

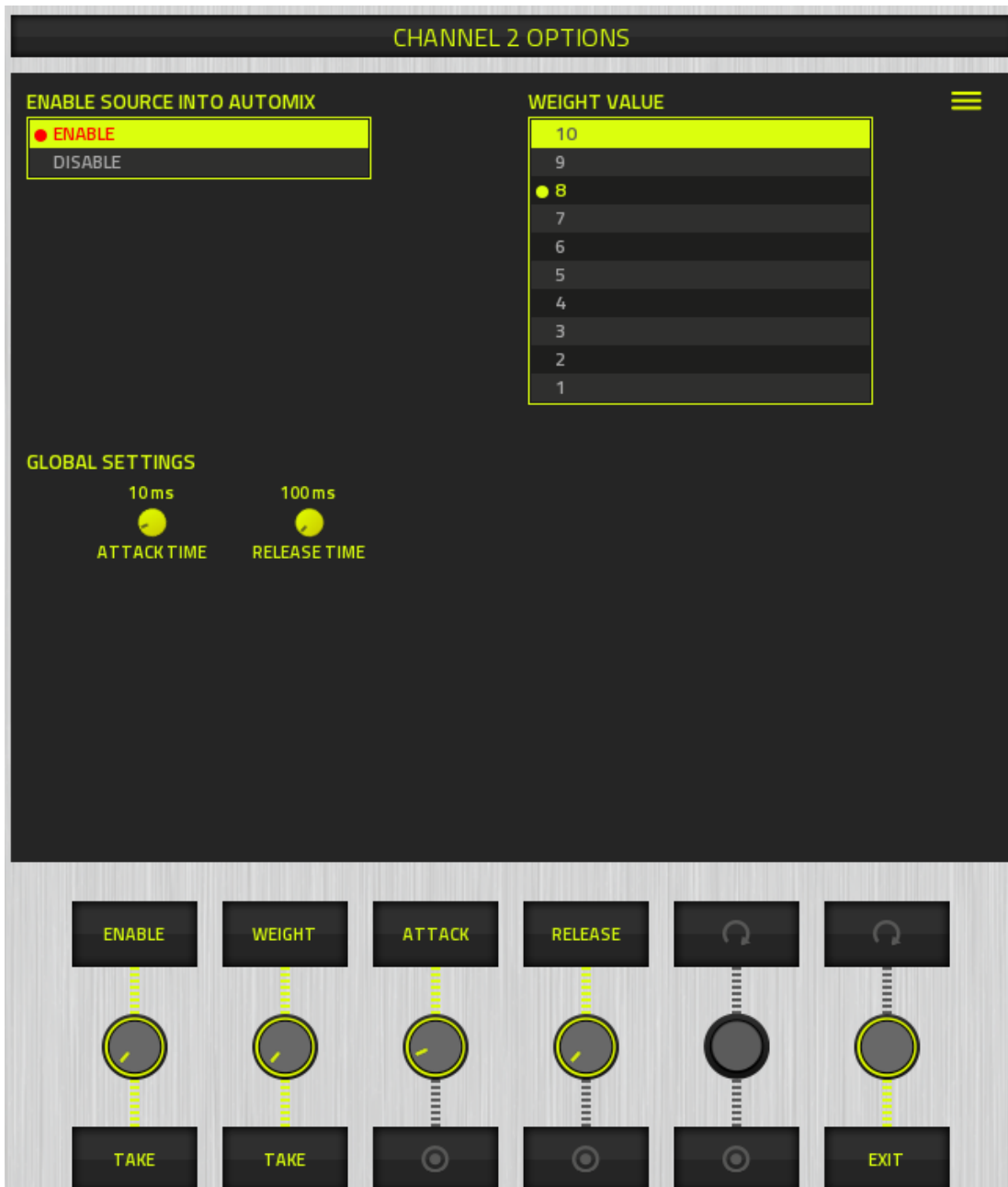

Fader Accessory Panel



The Fader Accessory Panel interconnects to the Fusion console interface board under the overbridge through the CANBUS. On the underside is a multi-select switch which addresses the module on the bus. Make sure each module has a unique ID (0 through E) before installing.

Once connected, the module will be ready for configuration on the **User Modules** page.

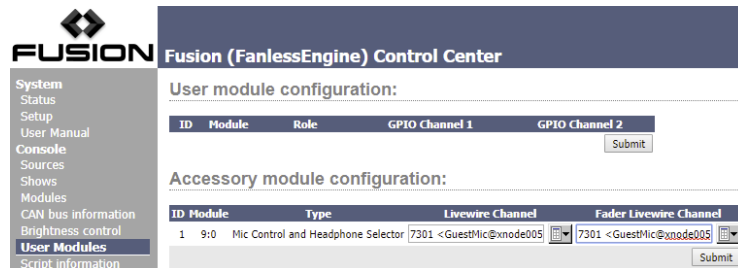

There are two fields to set, “Livewire Channel” and “Fader Livewire Channel”. The “Livewire Channel” will assign the buttons and headphone selector to a source. The “Fader Livewire Channel” will assign fader to a source. This allows for flexibility in how the panel is used. So the panel can be configured for a host position where the host controls her headphone, her ON state, and fader position or the fader can be used for say the host PC if she plays audio files from the PC. The panel will not light up unless the sources are loaded to a channel of the console.

AES67/SIP-Unicast

Vmode is used to ingest and egress AES67 defined streams. Version 3.2 introduces support for unicast streams as defined in AES67. Behind the scene, the receiving device would issue a SIP request to the sending device. This under the hood technology is in place. On the UI side there are instructions to enter SIP URI for the reception of a unicast stream, for example sip:8@192.168.101.73. On the transmit side, set the Stream type to “Disabled (SIP connections possible)”. At the far end, the SIP URI to be entered to receive the unicast stream from the engine would be sip:{number of vmode}@{IP of Engine}, for example sip:10@192.168.101.58.

Version 3.1 added the following features:

- Add support for loudness metering based on ITU.BS1770 and supporting EBU R128.
- Add support for “Live mode” control of Voco8.
- Add support for Source “Unload”. Removes a source from console that has ownership of a source, permitting other console to take ownership.
- Add AES67 support in Studio Engine
- Support Accessory Panel Support and control of Custom Headphone backfeeds.
- Add Phase meter to display.

Source “unload”

When loading shared resources, typically a facility codec, and said resource is in ownership by another studio, the console will load the source into *Listen Only* mode. This permits the console to have access of the audio from source, but is not able to control the source or provide backfeed audio. The console will provide indication of who is the owner of the source so that the source so action can take place if the newly requesting console can take ownership. In some cases, the last operator of that other studio may have left, requiring someone to walk but customers have told us they don't want to walk down to the other studio. The *Request Unload* option now appears on general **Channel Option** screen when a source is loaded in *Listen Only* mode. Pressing the *Request Unload* function will open a new view requiring the operator to rotate the first knob and select the confirmation that the source is to be unloaded. By pressing the knob in, after selecting to unload, requires a three step process to unload the source from the other console. This is a security feature to avoid accidental operations. If the source is in the ON state on the active owner, the source will not unload as an extra protection and the requesting console will remain in *Listen Only* mode.

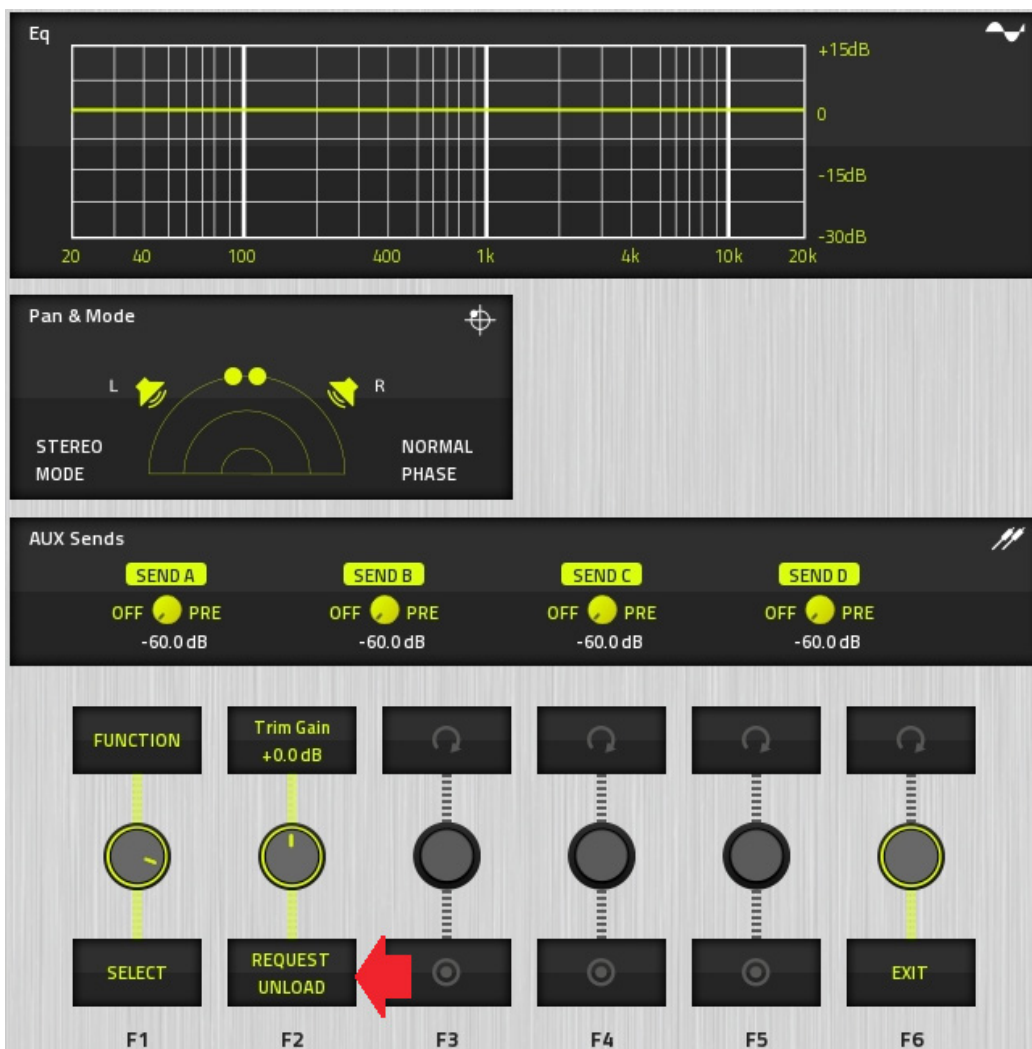

AES67 support

Version 3.1 introduces support for AES67 in the Studio Engine. This support is introduced in VMode and is further discussed in the VMODE section of Chapter 4 of the manual. With VMode, it is possible to convert AES67 streams with Livewire streams.

Intentionally Left Blank

Intentionally Left Blank

Intentionally Left Blank



THE TELOS ALLIANCE®

The Telos Alliance • 1241 Superior Ave. • Cleveland, Ohio, 44114, USA • +1.216.241.7225 • TelosAlliance.com

© 2017 TLS Corp. Axia® The Telos Alliance.® All Rights Reserved. C16/4/16002